

ALCO Controls **EX4 / EX5 / EX6 / EX7 / EX8** are stepper motor driven valves for precise control of refrigerant mass flow in air conditioning, refrigeration, heat pumps, close control, and industrial process cooling applications.

The Control Valves can be used as thermo-expansion duty, liquid injection duty, hot gas bypass, evaporator pressure regulator, crankcase pressure regulator, head pressure regulator, or liquid level control.

This data sheet describes only the performance of the valves. Operation of required controllers, driver boards and sensors are part of other documentations (see page 29).

Features

- Multifunction as expansion valves, hot gas bypass, suction gas throttling, head pressure, liquid level actuator etc.
- Fully hermetic design (no thread joints between valve body and motor compartment)
- Applicable to all common refrigerants (HCFC, HFC) and for subcritical CO₂ applications
- Stepper motor driven
- Short opening and closing time
- Very fast full stroke time
- High resolution and excellent repeatability
- Bi-flow versions for heat pump applications
- Positive shut-off function to eliminate the use of an additional solenoid valve
- Linear flow capacity
- Extremely wide capacity range (10 ... 100%)
- Continuous modulation of mass flow, no stress (liquid hammering) in the refrigeration circuit
- Direct coupling of motor and valve for high reliability (no gear mechanism)
- Ceramic slide and port for accurate flow and minimal wear
- Balanced force design
- Corrosion resistant stainless steel body and connections
- Europe patent No. 0743476, USA patent No. 5735501, Japan patent No. 28225789



EX4 / EX5 / EX6 (Uni-flow/Bi-flow)



EX7 (Uni-flow/Bi-flow)



EX8 (Uni-flow)

Selection table

Type	Part No.	Flow pattern	Capacity range	Inlet connection	Outlet connection	Electric connector
EX4-I21	800 615	Uni-flow	10 ... 100%	3/8" ODF	5/8" ODF	M12 plug
EX4-M21	800 616			10 mm ODF	16 mm ODF	
EX5-U21	800 618			5/8" (16 mm) ODF	7/8" (22 mm) ODF	
EX6-I21	800 620			7/8" ODF	1-1/8" ODF	
EX6-M21	800 621			22 mm ODF	28 mm ODF	
EX7-I21	800 624			1-1/8" ODF	1-3/8" ODF	
EX7-M21	800 625			28 mm ODF	35 mm ODF	
EX8-M21	800 629			42 mm ODF	42 mm ODF	
EX8-U21	800 630			1-3/8" (35 mm) ODF	1-3/8" (35 mm) ODF	
EX8-I21	800 631			1-5/8" ODF	1-5/8" ODF	
EX4-U31	800 617	Bi-flow (Heat pump)		5/8" (16 mm) ODF	5/8" (16 mm) ODF	
EX5-U31	800 619			7/8" (22 mm) ODF	7/8" (22 mm) ODF	
EX6-I31	800 622			1-1/8" ODF	1-1/8" ODF	
EX6-M31	800 623			28 mm ODF	28 mm ODF	
EX7-U31	800 626			1-3/8" (35 mm) ODF	1-3/8" (35 mm) ODF	

EX4/5/6/7/8 are delivered without cable/connector assembly (order separately).

Cable and connector assembly

Type	Part No.	Temperature Range	Length	Connector type to valve	Connector type to driver board or controller	Illustration
EXV-M15	804 663	-50 ... +80°C	1.5 m	M12	Loose wires	
EXV-M30	804 664		3.0 m			
EXV-M60	804 665		6.0 m			

Introduction

Thermostatic expansion valves and mechanical regulator valves have been used in the refrigeration and air conditioning industry to control superheat and refrigerant mass flow since its very beginning. As today's systems require improved energy efficiency, tighter temperature control, wider range of operating conditions and incorporate new features like remote monitoring and diagnostics, the application of electronically operated valves becomes mandatory. Only they offer the controls performance necessary to meet these needs.

As more new refrigerants appear on the market requiring an ever increasing number of different charges and settings for thermostatic expansion valves, electrical control valves can solve this problem too.

ALCO electrical control valves are the solution for the challenges above. The latest technology and more than 80 years of experience in design and production of flow controls including Thermo[®] expansion valves have been incorporated in the design of the EX4, EX5, EX6, EX7 and EX8.

Construction

EX4/EX5/EX6/EX7/EX8 consist of two main internal assemblies, the valve and the stepper motor. The stepper motor is connected directly to the slide and cage assembly of the valve. Similar to the technology used in compressors, the motor is exposed to refrigerant and lubricant and the materials used are identical. The housing of the motor and valve assembly is fully hermetic, utilising exclusively brazing and welding technologies and eliminating all gaskets.

This design offers several technical advantages. The motor is direct coupled to the valve assembly for easy and reliable movement of the valve slide, no need for any other seals and eliminating the use of bellows and diaphragms which could be subject to lifetime limitations and leaks.

Four electrical pins connect the motor to the outside. These pins are applied to the housing using melting-glass process technology. The EX4/5/6/7/8 pins require a M12 electrical connector.

The complete housing of the ECVs is made from stainless steel. Unlike to mechanical expansion valves, EX4/5/6/7/8 are equipped with ceramic slide port.

Features:

- Wide range regulation (10 ... 100%) with one slide orifice for each valve
- Linear characteristic over entire capacity range
- Positive shut-off

Guidelines for selection of electrical control valves

The following guideline should be taken in to the consideration in order to obtain full advantages of ECV:

- Published capacities are maximum. There are no reserve capacities.
- Larger size of valve leads to shorter pull down period and shorter travel time i.e. faster respond. For example, EX7 has maximum 3.2 seconds travel time. The valve has approximately 1.6 seconds travel time at 50% capacity operation.

ALCO Selection Tool

To facilitate valve dimensioning for other than the standard conditions ALCO offers an Excel based Selection Tool. This can be downloaded from www.emersonclimate.eu.

Example:

System with R407C having two different operating conditions:

- A)** 110 kW capacity at +4°C/+50°C with two stages compressor at 50%/100% capacity
- B)** 137 kW at +4°C/+30°C with two stages compressor at 50%/100% capacity

EX6 with 126 kW covers condition A, however is not sufficient to cover condition B. It is recommended to select the larger valve EX7 which offers 337 kW at condition A and 293 kW at condition B.

Condition A:

$$\text{Full load ratio} = \frac{110}{337} = 33\%$$

$$\text{Partial load ratio} = \frac{(110/2)}{337} = 16\%$$

Condition B:

$$\text{Full load ratio} = \frac{137}{293} = 47\%$$

$$\text{Partial load ratio} = \frac{(137/2)}{293} = 23\%$$

The capacity ratios of system to valve are in all conditions higher than 10%. It is recommended to use EX7 rather EX6.

EX4/EX5/EX6/EX7/EX8 nominal and extended capacities as expansion valves and liquid injection valves

Nominal Capacities (10% ... 100%), kW

Valve Type	R 407C	R 22	R 134a	R 404A	R 410A	R 23	R 124	R 744
EX4	2 ... 17.4	2 ... 16.5	1 ... 12.8	1 ... 11.5	2 ... 19.3	2 ... 17.8	1 ... 9.2	3 ... 33.5
EX5	5 ... 53	5 ... 50	4 ... 39	4 ... 35	6 ... 58	5 ... 54	3 ... 28	10 ... 102
EX6	15 ... 126	15 ... 120	10 ... 93	10 ... 84	15 ... 140	13 ... 130	7 ... 67	24 ... 244
EX7	35 ... 347	35 ... 330	25 ... 255	25 ... 230	40 ... 385	-	-	70 ... 670
EX8	100 ... 925	90 ... 880	70 ... 680	60 ... 613	100 ... 1027	-	-	180 ... 1789

Note 1: EX Bi-flow versions are not released for use with R124 and R23 refrigerants.

Note 2: EX Bi-flow versions have identical capacity in both flow direction.

The nominal capacity (Qn) is based on the following conditions:

Refrigerant	Evaporating temperature	Condensing temperature	Subcooling
R 22, R 134a, R 404A, R 410A	+4°C	+38°C	1K
R 407C	+4°C dew point	+38°C bubble / +43°C dew point	1K
R 124	+20°C	+80°C	1K
R 23	-60°C	-25°C	1K
R 744	-40°C	-10°C	1K

Overview of working pressure regardless of applied refrigerant type

Valve type	Flow pattern	Maximum working pressure PS	Factory test pressure PT
EX4, EX5, EX6, EX7	Uni-flow/Bi-flow	45 bar	49.5 bar
EX8	Uni-flow	45 bar	49.5 bar

Capacity Diagrams (kW)

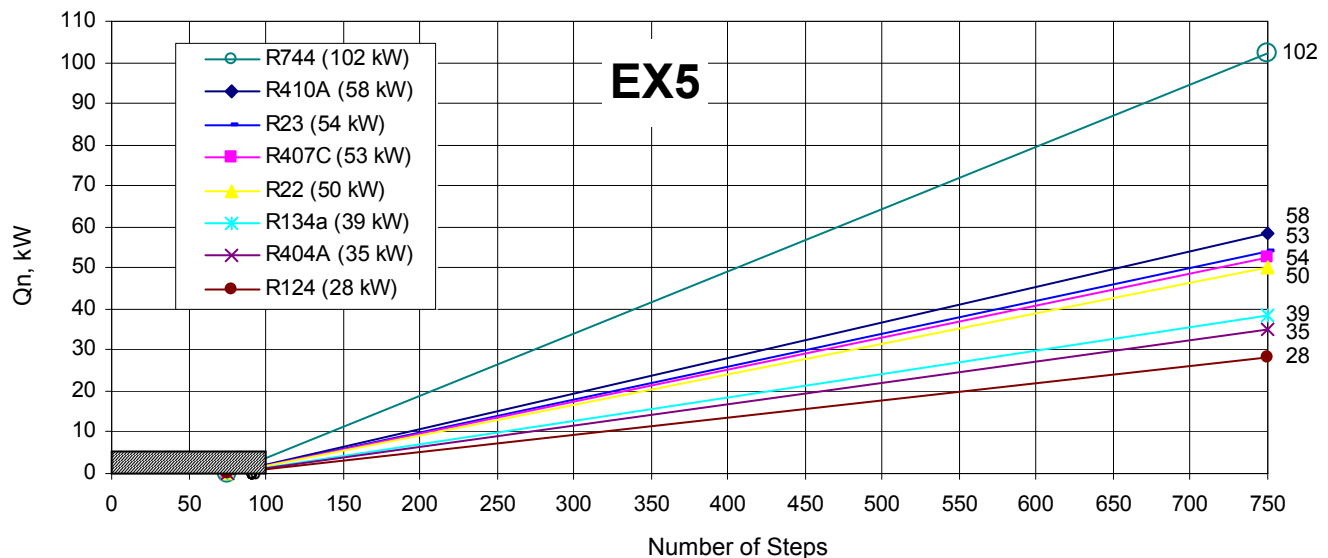
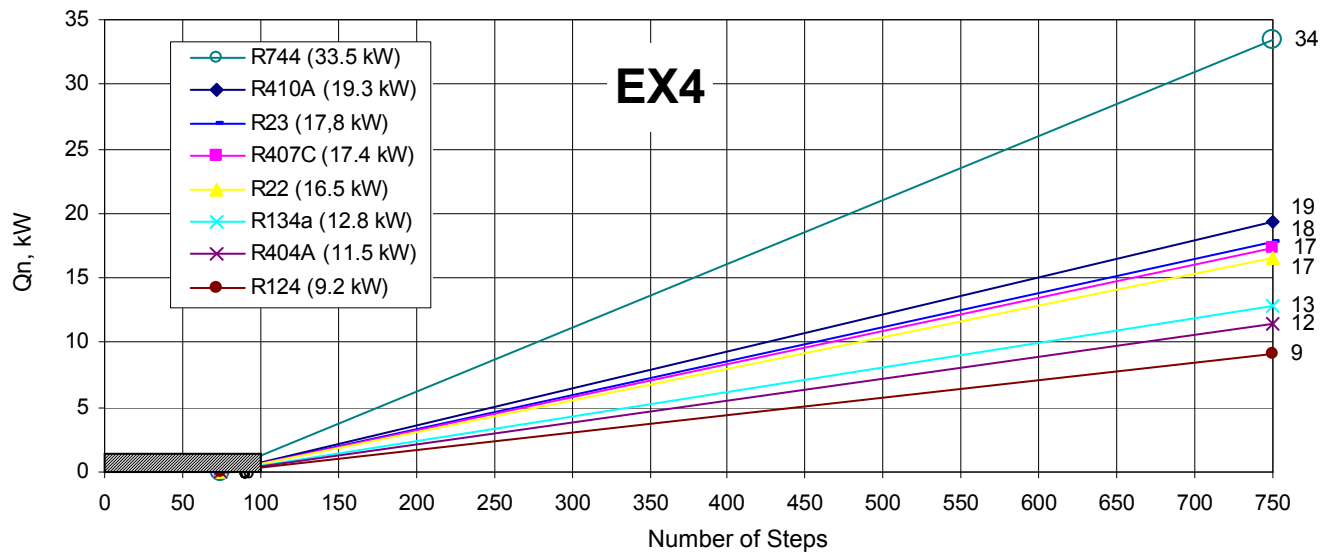

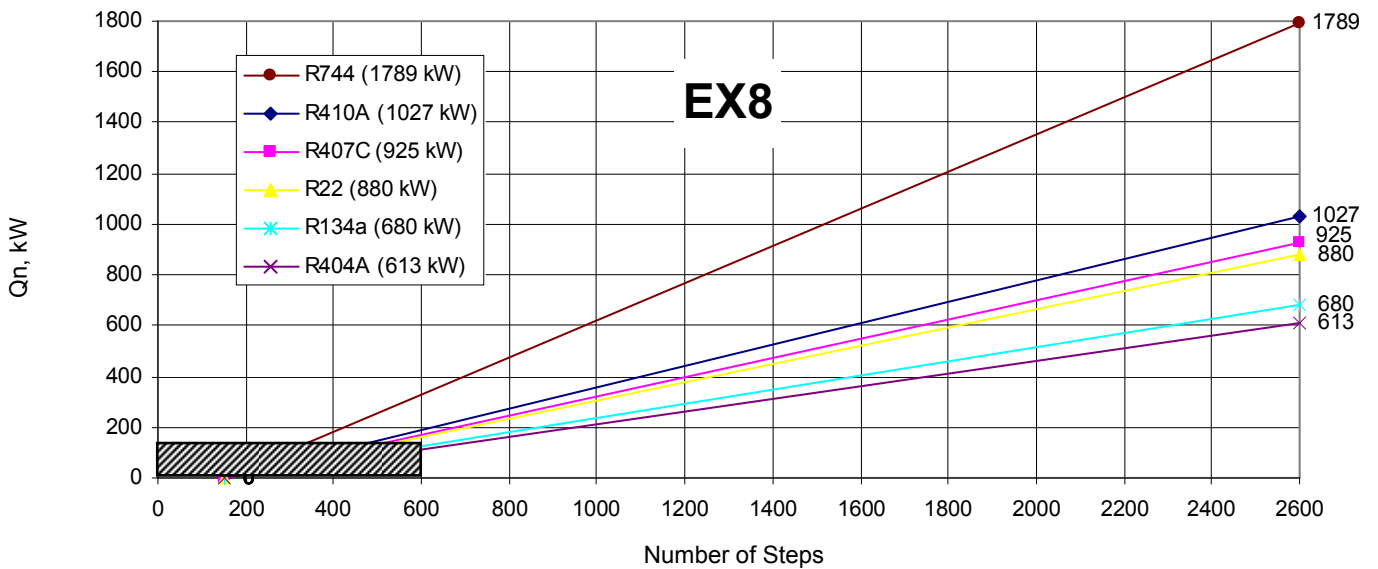
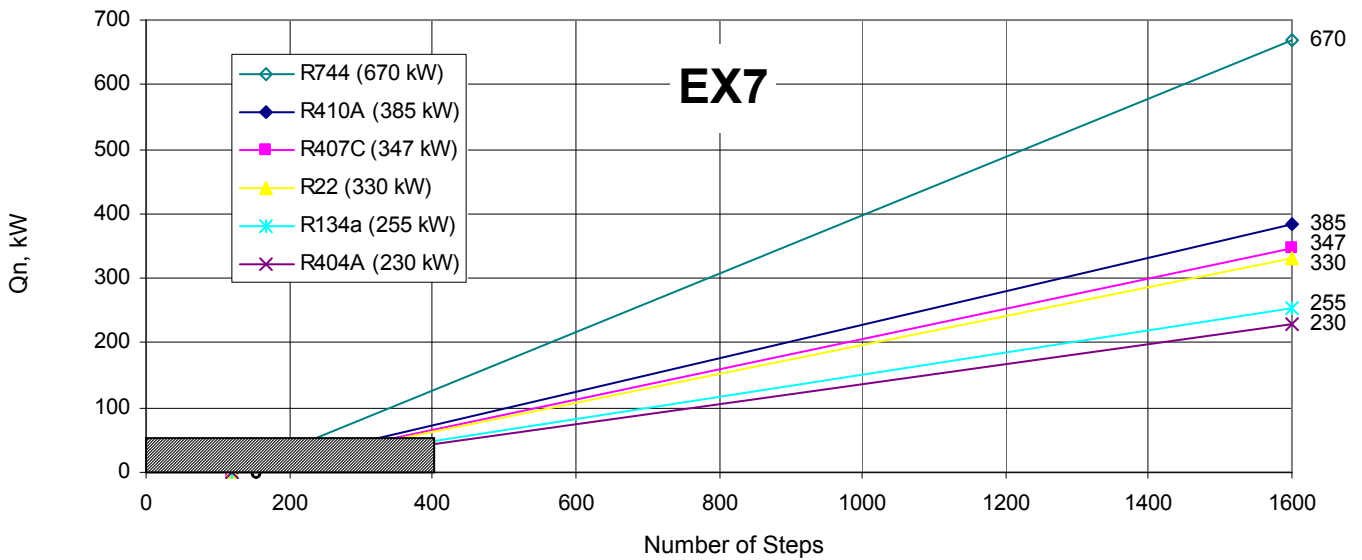
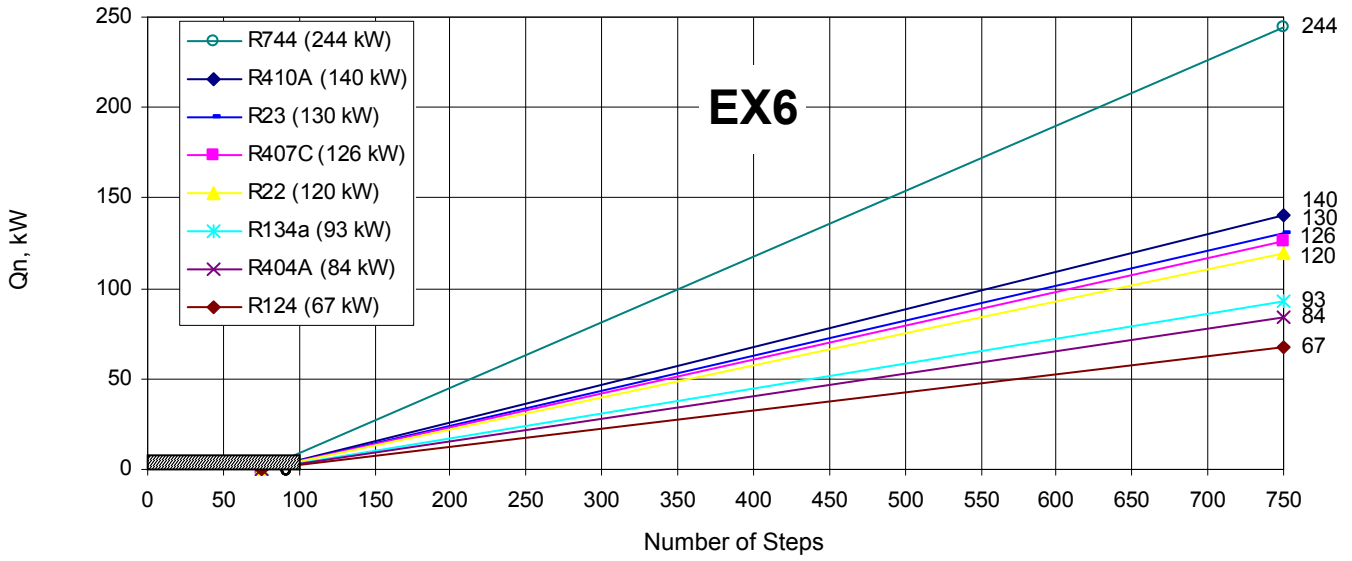

Extended capacities as expansion and liquid injection valves

The following tables provide the capacity of valves at different conditions considering **1.5 bar pressure drop** through liquid line:

Condensing temperature °C	R 410A Extended capacity kW													Valve Type
	Evaporating temperature °C													
	15	10	5	0	-5	-10	-15	-20	-25	-30	-35	-40	-45	
60	17	17	18	18	18	18	18	18	18	18	17	17	17	EX4
	51	52	53	54	54	54	54	54	53	53	52	51	50	EX5
	123	126	129	130	131	131	131	130	129	127	125	123	120	EX6
	339	348	354	358	360	361	360	358	354	350	344	338	331	EX7
	-	-	-	-	-	-	-	-	-	-	-	-	-	EX8
55	18	18	19	19	19	19	19	19	19	19	19	18	18	EX4
	53	55	56	57	57	58	58	58	57	57	56	55	54	EX5
	127	132	135	137	138	139	139	139	138	137	135	133	131	EX6
	350	362	370	377	381	383	383	382	380	377	372	366	360	EX7
	935	965	988	1005	1016	1021	1023	1020	1014	1005	992	978	961	EX8
50	18	18	19	19	20	20	20	20	20	20	20	19	19	EX4
	53	55	57	58	59	60	60	60	60	59	59	58	57	EX5
	128	133	137	140	142	144	145	145	144	143	142	140	138	EX6
	351	366	377	386	392	396	398	398	397	394	391	386	380	EX7
	936	975	1006	1029	1045	1056	1061	1062	1059	1052	1043	1030	1015	EX8
45	17	18	19	19	20	20	20	20	20	20	20	20	20	EX4
	52	54	57	58	60	60	61	61	61	61	61	60	59	EX5
	124	131	136	141	144	146	147	148	148	147	146	145	143	EX6
	342	361	375	387	395	401	405	407	407	405	403	399	394	EX7
	913	962	1001	1031	1054	1070	1080	1085	1085	1082	1075	1064	1052	EX8
40	16	17	18	19	20	20	20	21	21	21	21	20	20	EX4
	49	52	55	57	59	60	61	62	62	62	62	61	61	EX5
	118	126	133	138	142	145	147	149	149	149	149	148	146	EX6
	324	348	366	381	392	400	406	409	411	411	409	406	402	EX7
	864	927	977	1015	1045	1067	1082	1091	1095	1095	1091	1084	1073	EX8
35	15	16	18	18	19	20	20	20	21	21	21	20	20	EX4
	45	49	53	55	58	59	60	61	62	62	62	62	61	EX5
	108	118	127	134	139	143	146	148	149	149	149	149	148	EX6
	296	326	349	368	382	393	401	406	409	411	410	409	406	EX7
	789	869	932	981	1019	1048	1069	1083	1092	1095	1095	1090	1082	EX8
30	13	15	16	17	18	19	20	20	20	20	20	20	20	EX4
	38	44	49	52	55	57	59	60	61	61	61	61	61	EX5
	93	107	118	126	133	138	142	145	147	148	148	148	147	EX6
	255	294	325	348	366	380	390	398	403	406	407	406	405	EX7
	680	786	866	928	976	1013	1041	1061	1075	1083	1086	1084	1079	EX8
25	10	13	15	16	17	18	19	19	20	20	20	20	20	EX4
	29	38	44	48	52	54	56	58	59	60	60	60	60	EX5
	71	91	106	117	125	131	136	140	143	144	145	146	145	EX6
	195	251	291	321	344	361	375	385	392	397	399	400	399	EX7
	520	669	775	855	916	964	1000	1027	1046	1058	1065	1067	1065	EX8
20	4	9	12	14	16	17	18	18	19	19	19	20	20	EX4
	13	28	37	43	47	51	53	55	57	58	58	59	59	EX5
	31	68	89	103	114	122	129	133	137	139	141	142	142	EX6
	84	188	244	284	314	337	354	367	377	383	388	390	390	EX7
	225	501	652	758	837	898	944	979	1005	1023	1034	1040	1042	EX8
15		3	9	12	14	15	16	17	18	18	19	19	19	EX4
		10	27	36	42	46	49	52	54	55	56	57	57	EX5
		23	65	86	100	111	119	125	130	133	135	137	137	EX6
		64	178	236	276	305	327	344	357	366	372	376	378	EX7
		172	475	629	735	813	873	917	951	976	992	1003	1008	EX8
10			1	8	11	13	15	16	17	17	18	18	18	EX4
			4	25	34	40	44	47	50	52	53	54	55	EX5
			10	60	82	96	107	115	121	125	128	130	132	EX6
			28	166	225	265	294	315	332	344	352	358	362	EX7
			76	443	600	706	783	841	885	917	940	956	965	EX8

D A T A S H E E T

Extended capacities as expansion and liquid injection valves

The following tables provide the capacity of valves at different conditions considering **1.5 bar pressure drop** through liquid line:

Condensing temperature		Extended capacity kW													Valve type
Dew point °C	Bubble point °C	R 407C													
		Evaporating temperature °C													
		15	10	5	0	-5	-10	-15	-20	-25	-30	-35	-40	-45	
64	60	16	17	17	17	17	17	16	16	15	15	15	14	14	EX4
		50	51	51	51	51	50	50	49	48	47	46	45	43	EX5
		119	120	121	121	121	119	118	116	114	112	109	106	103	EX6
		328	332	333	333	332	329	325	320	314	308	301	293	285	EX7
		874	884	889	889	885	877	867	854	838	821	802	781	759	EX8
59	55	17	17	17	17	17	17	17	16	16	16	15	15	15	EX4
		50	51	52	52	52	51	51	50	49	48	47	46	46	EX5
		120	122	123	124	124	123	122	121	119	117	114	112	109	EX6
		330	336	339	341	341	339	336	332	328	322	315	308	301	EX7
		879	895	904	909	908	904	897	886	873	858	840	821	801	EX8
54	50	16	17	17	17	17	17	17	17	17	17	16	16	16	EX4
		50	51	52	52	53	53	52	52	51	51	50	49	48	EX5
		118	121	123	125	125	125	125	123	122	120	118	116	113	EX6
		326	334	340	343	345	345	343	340	336	331	325	319	312	EX7
		869	891	906	915	919	919	914	907	896	883	868	851	832	EX8
50	45	16	16	17	17	17	17	17	17	17	17	17	16	16	EX4
		48	50	51	52	53	53	53	52	52	51	51	50	49	EX5
		115	119	122	124	125	125	125	125	124	122	120	118	116	EX6
		316	327	336	341	344	346	345	344	341	337	332	326	320	EX7
		843	873	894	909	918	921	920	916	908	897	884	869	853	EX8
45	40	15	16	16	17	17	17	17	17	17	17	17	16	16	EX4
		46	48	50	51	52	52	52	52	52	52	51	50	49	EX5
		109	114	118	121	123	124	125	125	124	123	121	120	118	EX6
		300	315	326	334	339	342	344	343	341	338	334	330	324	EX7
		801	840	870	891	905	913	916	915	910	902	891	878	864	EX8
40	35	14	15	16	16	17	17	17	17	17	17	17	17	16	EX4
		42	45	48	49	50	51	52	52	52	51	51	50	50	EX5
		101	108	113	117	120	122	123	123	123	122	121	120	118	EX6
		278	297	312	323	330	335	338	339	338	337	334	330	325	EX7
		742	793	832	860	880	894	901	904	902	897	889	879	866	EX8
35	30	12	14	15	15	16	16	16	17	17	17	17	16	16	EX4
		38	42	45	47	48	49	50	51	51	51	50	50	49	EX5
		90	99	106	111	115	118	119	120	121	120	120	119	117	EX6
		248	273	292	306	317	324	329	331	332	331	329	326	323	EX7
		661	729	779	817	844	864	876	883	885	884	878	870	860	EX8
30	25	10	12	13	14	15	15	16	16	16	16	16	16	16	EX4
		32	37	41	44	46	47	48	49	49	49	49	49	48	EX5
		75	88	97	103	108	112	115	116	117	117	117	116	115	EX6
		207	241	266	285	299	309	316	320	322	323	322	320	317	EX7
		552	644	710	760	796	823	841	853	860	861	859	854	846	EX8
26	20	7	10	12	13	14	14	15	15	16	16	16	15	15	EX4
		23	30	36	39	42	44	46	47	47	48	48	48	47	EX5
		54	72	85	94	100	105	108	111	112	113	113	113	112	EX6
		148	199	233	258	276	289	299	305	309	312	312	311	309	EX7
		395	530	621	687	735	770	796	814	825	831	832	829	824	EX8
21	15		7	9	11	12	13	14	14	15	15	15	15	15	EX4
			21	29	34	38	40	42	44	45	45	46	46	46	EX5
			50	69	81	90	96	101	104	106	108	108	109	108	EX6
			137	189	223	247	265	277	287	293	297	299	299	298	EX7
			365	503	594	658	705	740	764	781	791	796	797	795	EX8
16	10			6	9	11	12	13	13	14	14	14	14	14	EX4
				19	27	32	36	38	40	42	43	43	43	43	EX5
				45	64	76	85	91	96	99	101	103	103	103	EX6
				123	176	210	234	251	264	273	279	282	284	284	EX7
				329	470	561	624	670	704	727	743	753	757	758	EX8

Extended capacities as expansion and liquid injection valves

The following tables provide the capacity of valves at different conditions considering **1.5 bar pressure drop** through liquid line:

Condensing temperature °C	Extended capacity kW													Valve Type
	R 22													
	Evaporating temperature °C													
	15	10	5	0	-5	-10	-15	-20	-25	-30	-35	-40	-45	
60	17	17	18	18	18	18	18	18	18	17	17	17	17	EX4
	51	52	53	54	54	54	54	54	53	53	52	52	51	EX5
	123	126	128	129	130	130	130	129	128	127	126	124	122	EX6
	337	345	351	355	357	358	357	356	353	350	345	340	335	EX7
	900	921	936	946	952	954	953	948	941	932	921	908	893	EX8
55	16	17	17	18	18	18	18	18	18	18	17	17	17	EX4
	50	51	52	53	54	54	54	54	54	53	53	52	52	EX5
	119	123	126	128	129	130	130	130	129	128	127	126	124	EX6
	328	339	346	352	355	357	358	357	356	353	350	345	340	EX7
	876	903	923	938	948	953	955	953	949	941	932	921	908	EX8
50	16	16	17	17	18	18	18	18	18	18	18	17	17	EX4
	48	50	51	52	53	54	54	54	54	54	53	53	52	EX5
	114	119	123	125	127	129	129	129	129	128	127	126	125	EX6
	314	327	337	345	350	354	355	356	355	353	351	347	343	EX7
	838	873	899	919	933	943	948	949	947	942	935	925	914	EX8
45	15	16	16	17	17	17	17	18	18	18	17	17	17	EX4
	45	47	49	51	52	52	53	53	53	53	53	52	52	EX5
	107	113	118	121	124	126	127	128	128	127	127	126	124	EX6
	295	311	324	334	341	346	349	351	351	350	348	346	342	EX7
	787	830	864	890	909	923	932	936	937	934	929	922	912	EX8
40	13	15	15	16	16	17	17	17	17	17	17	17	17	EX4
	41	44	46	48	50	51	52	52	52	52	52	52	51	EX5
	98	106	111	116	119	122	124	125	125	125	125	124	123	EX6
	270	290	306	319	328	335	340	343	345	345	344	342	339	EX7
	719	774	817	850	875	894	907	915	919	919	916	911	903	EX8
35	12	13	14	15	16	16	16	17	17	17	17	17	17	EX4
	36	40	43	45	47	49	50	50	51	51	51	51	50	EX5
	86	96	103	109	113	117	119	121	122	122	122	122	121	EX6
	237	264	284	300	312	321	327	332	335	336	336	335	333	EX7
	632	703	757	799	831	856	873	885	893	896	896	893	888	EX8
30	10	11	13	14	15	15	16	16	16	16	16	16	16	EX4
	29	35	39	42	44	46	47	48	49	49	49	49	49	EX5
	70	83	93	100	106	110	113	116	117	118	118	118	118	EX6
	194	229	256	276	291	303	312	318	322	325	326	326	324	EX7
	516	611	682	735	776	808	831	848	859	866	869	868	865	EX8
25	7	9	11	12	13	14	15	15	15	16	16	16	16	EX4
	20	28	33	37	40	43	44	46	46	47	47	48	48	EX5
	47	67	80	90	97	102	106	109	112	113	114	114	114	EX6
	130	184	220	246	266	281	292	301	307	311	313	314	314	EX7
	347	491	587	656	709	749	779	802	818	829	835	837	836	EX8
20		6	9	10	12	13	13	14	14	15	15	15	15	EX4
		18	26	32	36	39	41	42	44	45	45	45	46	EX5
		43	63	76	85	93	98	102	105	107	108	109	109	EX6
		117	173	209	235	254	269	280	288	294	298	300	300	EX7
		312	461	557	627	678	718	747	768	784	793	799	801	EX8
15			5	8	10	11	12	13	13	14	14	14	14	EX4
			15	24	30	34	37	39	40	42	42	43	43	EX5
			37	58	71	81	88	93	97	100	102	103	104	EX6
			101	160	196	222	241	256	266	274	279	283	285	EX7
			269	426	524	593	644	682	710	731	745	754	759	EX8
10				4	7	9	10	11	12	13	13	13	13	EX4
				12	22	28	31	34	36	38	39	40	40	EX5
				29	53	66	76	82	87	91	94	96	97	EX6
				80	145	182	208	227	241	251	258	263	267	EX7
				214	386	485	554	604	642	669	689	702	711	EX8

Extended capacities as expansion and liquid injection valves

The following tables provide the capacity of valves at different conditions considering **1.5 bar pressure drop** through liquid line:

Condensing temperature °C	Extended capacity kW													Valve Type
	R 134a													
	Evaporating temperature °C													
	15	10	5	0	-5	-10	-15	-20	-25	-30	-35	-40	-45	
60	13	13	13	13	13	13	12	12	12	12	11	11	11	EX4
	39	39	39	39	39	39	38	37	36	35	34	33	32	EX5
	93	94	94	94	93	92	90	89	87	84	82	79	77	EX6
	255	257	258	257	255	252	248	243	237	231	224	217	210	EX7
	679	686	688	686	680	672	661	648	633	616	598	580	560	EX8
55	12	13	13	13	13	13	13	12	12	12	12	11	11	EX4
	38	39	39	39	39	39	38	38	37	36	35	34	33	EX5
	91	92	93	94	93	93	92	90	88	86	84	82	80	EX6
	249	253	256	257	256	254	251	247	242	237	231	225	218	EX7
	663	676	683	685	683	678	670	659	647	632	616	599	582	EX8
50	12	12	13	13	13	13	13	12	12	12	12	12	11	EX4
	36	38	38	39	39	39	38	38	37	37	36	35	34	EX5
	87	90	91	92	93	92	92	91	89	88	86	84	81	EX6
	238	246	250	253	254	253	251	249	245	240	235	229	223	EX7
	636	655	668	675	677	676	671	663	653	640	627	611	595	EX8
45	11	12	12	12	12	13	12	12	12	12	12	12	11	EX4
	34	36	37	38	38	38	38	38	37	37	36	35	35	EX5
	81	85	88	90	91	91	91	90	89	88	86	84	82	EX6
	223	234	241	246	248	249	249	247	244	240	236	231	226	EX7
	595	623	642	655	662	664	663	658	651	641	629	616	602	EX8
40	10	11	11	12	12	12	12	12	12	12	12	12	11	EX4
	31	33	35	36	37	37	37	37	37	36	36	35	34	EX5
	74	79	83	85	87	88	89	88	88	87	85	84	82	EX6
	202	217	227	234	239	242	243	242	240	238	234	230	225	EX7
	539	578	606	625	638	645	647	646	641	634	625	614	601	EX8
35	9	10	10	11	11	12	12	12	12	12	12	11	11	EX4
	27	30	32	34	35	35	36	36	36	36	35	35	34	EX5
	63	71	76	80	83	84	85	86	85	85	84	83	81	EX6
	173	194	209	219	226	231	234	235	234	232	230	227	223	EX7
	463	517	556	584	604	616	623	625	624	620	613	604	594	EX8
30	7	8	9	10	11	11	11	11	11	11	11	11	11	EX4
	20	25	28	30	32	33	34	34	34	34	34	34	33	EX5
	49	60	67	73	76	79	81	82	82	82	81	80	79	EX6
	133	164	184	199	210	217	221	224	225	224	223	221	217	EX7
	356	436	492	531	559	578	590	597	600	599	595	588	580	EX8
25	3	6	8	9	9	10	10	11	11	11	11	11	11	EX4
	10	18	23	26	29	30	31	32	33	33	33	32	32	EX5
	23	44	55	63	69	72	75	77	78	78	78	77	76	EX6
	63	121	152	173	188	198	206	210	213	214	213	212	210	EX7
	169	322	406	462	501	529	548	560	567	570	569	565	559	EX8
20		2	5	7	8	9	9	10	10	10	10	10	10	EX4
		5	16	21	25	27	28	29	30	31	31	31	31	EX5
		12	38	51	58	64	68	70	72	73	73	73	73	EX6
		34	105	139	160	175	186	193	197	200	201	201	199	EX7
		90	281	370	427	467	495	514	526	533	536	535	532	EX8
15				4	6	7	8	9	9	9	9	9	9	EX4
				13	19	22	25	26	27	28	28	29	29	EX5
				32	45	53	59	62	65	67	68	68	68	EX6
				87	123	145	161	171	178	183	186	187	187	EX7
				231	328	388	428	456	475	488	495	498	498	EX8
10					3	5	6	7	8	8	8	9	9	EX4
					9	16	20	22	24	25	26	26	26	EX5
					22	38	47	52	56	59	61	62	62	EX6
					61	104	128	144	155	162	167	170	171	EX7
					162	277	341	384	413	432	445	452	455	EX8

Extended capacities as expansion and liquid injection valves

The following tables provide the capacity of valves at different conditions considering **1.5 bar pressure drop** through liquid line:

Condensing temperature °C	Extended capacity kW													Valve Type
	R 404A / R507													
	Evaporating temperature °C													
	15	10	5	0	-5	-10	-15	-20	-25	-30	-35	-40	-45	
60	9	9	9	9	9	9	9	8	8	8	7	7	6	EX4
	28	28	28	28	28	27	26	25	24	23	22	21	20	EX5
	68	68	68	67	66	65	63	61	58	56	53	50	47	EX6
	186	187	186	184	181	177	172	166	160	153	145	137	129	EX7
	495	498	496	491	482	471	458	443	425	407	387	366	344	EX8
55	10	10	10	10	10	10	10	9	9	9	8	8	8	EX4
	30	31	31	31	30	30	29	29	28	27	26	25	23	EX5
	72	73	74	74	73	72	70	69	67	64	62	59	56	EX6
	198	201	202	202	200	197	193	188	182	176	169	162	154	EX7
	527	535	538	537	533	525	514	501	486	470	451	432	411	EX8
50	10	10	11	11	11	11	10	10	10	10	9	9	9	EX4
	31	32	32	32	32	32	32	31	30	30	29	28	27	EX5
	74	76	77	78	78	77	76	75	73	71	69	66	64	EX6
	203	208	211	213	213	211	208	204	200	194	188	181	174	EX7
	541	555	564	567	567	562	555	545	532	518	501	484	465	EX8
45	10	10	11	11	11	11	11	11	11	10	10	10	9	EX4
	31	32	33	33	33	33	33	33	32	32	31	30	29	EX5
	74	77	79	80	80	80	80	79	78	76	74	72	69	EX6
	201	210	215	219	220	220	219	216	212	208	202	196	190	EX7
	537	559	574	583	587	586	582	575	566	553	539	524	506	EX8
40	10	10	11	11	11	11	11	11	11	11	11	10	10	EX4
	29	31	33	33	34	34	34	34	34	34	33	32	31	EX5
	71	75	78	80	81	82	82	81	81	79	78	76	74	EX6
	193	205	214	219	223	225	225	223	221	217	213	208	202	EX7
	515	547	570	585	594	598	598	595	588	578	567	553	538	EX8
35	9	10	10	11	11	11	11	11	11	11	11	11	11	EX4
	27	30	31	33	34	34	34	34	34	34	33	33	32	EX5
	65	71	75	79	81	82	83	83	82	81	80	79	77	EX6
	178	195	207	215	221	225	226	226	225	223	219	215	210	EX7
	474	519	551	574	590	599	603	604	600	594	585	573	560	EX8
30	8	9	10	10	11	11	11	11	11	11	11	11	11	EX4
	23	27	30	31	33	34	34	34	34	34	34	33	33	EX5
	56	65	71	75	78	81	82	83	83	82	81	80	79	EX6
	153	177	194	206	215	221	224	226	226	225	223	219	215	EX7
	409	472	517	550	573	588	598	603	603	600	593	584	573	EX8
25	6	8	9	10	10	11	11	11	11	11	11	11	11	EX4
	17	23	27	29	31	32	33	34	34	34	34	34	33	EX5
	42	55	64	70	74	78	80	81	82	82	81	80	79	EX6
	114	150	174	191	204	213	218	222	224	224	223	220	217	EX7
	305	400	465	510	543	566	582	592	596	597	593	587	579	EX8
20	1	5	7	8	9	10	10	11	11	11	11	11	11	EX4
	3	16	22	26	28	30	32	33	33	33	33	33	33	EX5
	8	40	53	62	68	73	76	78	80	80	80	80	79	EX6
	21	108	146	170	187	200	208	214	218	219	220	218	216	EX7
	56	289	388	453	499	532	555	571	580	585	585	582	576	EX8
15			5	7	8	9	10	10	10	11	11	11	11	EX4
			15	21	25	28	29	31	32	32	32	33	32	EX5
			37	51	60	66	71	74	76	77	78	78	78	EX6
			101	139	164	181	194	202	208	212	213	214	213	EX7
			268	371	437	484	516	540	555	564	569	569	566	EX8
10				5	7	8	9	9	10	10	10	10	10	EX4
				14	20	24	26	28	30	31	31	31	31	EX5
				33	48	57	64	68	71	73	75	75	75	EX6
				91	131	156	174	186	195	201	204	206	206	EX7
				242	350	417	464	496	519	535	544	548	549	EX8

Extended capacities as expansion and liquid injection valves

The following tables provide the capacity of valves at different conditions considering 1.5 bar pressure drop through liquid line:

Condensing temperature °C	Extended capacity kW												Valve Type
	R 23												
	Evaporating temperature °C												
	-45	-50	-55	-60	-65	-70	-75	-80	-85	-90	-95	-100	
-10	17	18	19	19	19	19	19	19	19	19	19	18	EX4
	53	55	56	57	58	58	58	58	58	57	57	56	EX5
	127	132	135	138	139	140	140	140	139	138	137	135	EX6
-15	16	17	18	18	19	19	19	19	19	19	18	18	EX4
	50	52	54	55	56	57	57	57	57	57	56	55	EX5
	119	125	130	133	135	137	137	137	137	136	135	134	EX6
-20	15	16	17	17	18	18	18	18	18	18	18	18	EX4
	45	48	51	53	54	55	55	55	55	55	55	54	EX5
	109	117	122	127	130	132	133	134	133	133	132	131	EX6
-25	13	14	15	16	17	17	17	18	18	18	18	17	EX4
	40	44	47	49	51	52	53	53	53	53	53	53	EX5
	96	106	113	118	122	125	127	128	129	128	128	127	EX6
-30	11	13	14	15	16	16	16	17	17	17	17	17	EX4
	33	38	42	45	47	49	50	51	51	51	51	51	EX5
	78	92	101	108	114	117	120	122	122	123	123	122	EX6
-35	7	10	12	13	14	15	15	16	16	16	16	16	EX4
	22	30	36	40	43	45	46	47	48	48	48	48	EX5
	53	73	86	96	103	108	111	114	115	116	116	116	EX6
-40		6	9	11	12	13	14	14	15	15	15	15	EX4
		19	28	33	37	40	42	43	44	45	45	45	EX5
		46	67	80	90	96	101	104	106	108	108	108	EX6
-45			5	8	10	11	12	13	13	13	14	14	EX4
			15	25	30	34	37	39	40	41	41	41	EX5
			37	60	73	82	88	93	96	98	99	100	EX6

Condensing temperature °C	Extended capacity kW							Valve Type
	R 124							
	Evaporating temperature °C							
	30	25	20	15	10	5	0	
100	7	7	7	6	6	6	5	EX4
	22	21	20	19	18	17	16	EX5
	53	51	49	47	44	42	39	EX6
95	8	8	7	7	7	7	6	EX4
	24	23	23	22	21	20	19	EX5
	57	56	54	52	50	47	45	EX6
90	8	8	8	8	7	7	7	EX4
	25	25	24	24	23	22	21	EX5
	61	59	58	56	54	52	50	EX6
85	9	9	8	8	8	8	7	EX4
	26	26	25	25	24	23	23	EX5
	63	62	61	60	58	56	54	EX6
80	9	9	9	8	8	8	8	EX4
	27	27	26	26	25	25	24	EX5
	64	63	63	62	61	59	57	EX6
75	9	9	9	9	9	8	8	EX4
	27	27	27	26	26	25	25	EX5
	64	64	64	63	62	61	60	EX6
70	9	9	9	9	9	9	8	EX4
	26	26	27	27	26	26	25	EX5
	62	63	64	63	63	62	61	EX6
65	8	8	9	9	9	9	8	EX4
	25	26	26	26	26	26	26	EX5
	60	61	62	63	63	62	62	EX6
60	8	8	8	8	8	8	8	EX4
	23	24	25	26	26	26	26	EX5
	56	58	60	61	62	62	61	EX6

D A T A S H E E T

Extended capacities as expansion and liquid injection valves

The following tables provide the capacity of valves at different conditions considering 1.5 bar pressure drop through liquid line:

Condensing temperature °C	Extended capacity kW													Valve Type
	R 744													
	Evaporating temperature °C													
	8	5	0	-5	-10	-15	-20	-25	-30	-35	-40	-45	-50	
10	5	12	18	22	26	29	31	33	34	35	36	37	38	EX4
	15	36	55	68	79	87	94	99	104	108	110	113	114	EX5
	36	86	132	164	189	208	225	238	249	257	264	269	273	EX6
	99	237	362	450	518	572	617	653	683	707	726	740	750	EX7
	-	-	-	-	-	-	-	-	-	-	-	-	-	-
5			12	19	23	27	29	32	33	35	36	37	38	EX4
			37	57	71	81	90	96	102	106	110	113	115	EX5
			89	137	170	195	215	231	244	254	263	269	274	EX6
			244	376	466	535	589	634	670	699	722	739	753	EX7
			-	-	-	-	-	-	-	-	-	-	-	-
0				12	19	24	27	30	32	34	35	36	37	EX4
				38	58	72	83	91	98	103	107	111	113	EX5
				90	139	173	198	218	234	247	257	265	271	EX6
				247	383	475	544	598	642	677	705	727	744	EX7
				659	1023	1267	1452	1598	1715	1809	1883	1942	1987	EX8
-5					12	19	24	27	30	32	34	35	36	EX4
					37	59	73	83	91	98	103	107	110	EX5
					89	140	174	199	219	234	247	257	264	EX6
					245	385	477	547	601	644	678	705	725	EX7
					654	1028	1275	1460	1604	1718	1809	1881	1937	EX8
-10						12	19	24	27	30	32	34	35	EX4
						36	58	72	83	91	97	102	106	EX5
						87	139	173	198	217	233	245	254	EX6
						239	382	475	544	597	639	671	697	EX7
						639	1021	1269	1452	1594	1705	1793	1861	EX8
-15							11	19	23	27	29	31	33	EX4
							35	57	71	82	89	96	100	EX5
							84	137	171	195	214	229	240	EX6
							229	376	468	536	588	628	660	EX7
							613	1003	1250	1431	1570	1677	1761	EX8
-20								11	18	23	26	29	31	EX4
								33	56	70	80	87	93	EX5
								79	133	166	191	209	223	EX6
								216	365	457	523	574	613	EX7
								576	974	1220	1398	1532	1636	EX8
-25									10	18	22	25	28	EX4
									30	53	67	77	85	EX5
									72	128	161	185	202	EX6
									198	350	442	507	556	EX7
									528	935	1179	1353	1483	EX8
-30										9	17	21	24	EX4
										27	51	64	74	EX5
										64	121	154	177	EX6
										175	332	423	486	EX7
										466	887	1129	1298	EX8
-35											7	16	20	EX4
											22	47	61	EX5
											53	113	146	EX6
											145	310	400	EX7
											386	828	1068	EX8
-40												5	14	EX4
												16	43	EX5
												37	103	EX6
												103	284	EX7
												275	759	EX8

EX4/EX5/EX6/EX7/EX8 Nominal and extended capacities as hot gas bypass regulator

Nominal Capacities, kW

Valve Type	Kv, m ³ /h	R 22/R 407C	R 134a	R 404A/R 507
EX4	0.21	4.9	3.4	4.6
EX5	0.68	16	11	15
EX6	1.57	37	26	35
EX7	5.58	131	92	126
EX8	16.95	399	278	382

The nominal capacity (Qn) is based on the following conditions:

Refrigerant	Evaporating temperature	Condensing temperature	Subcooling
R 22, R 134a, R 404A, R 507	+4°C	+38°C	1K
R 407C	+4°C dew point	+38°C bubble / +43°C dew point	1K

Remarks: Note 1: Bi-flow versions are not released for hot gas bypass applications.

Note 2: EX4, EX5, EX6, EX7 and EX8 must be installed with motor downward in hot gas line applications.
This insures the valve life expectancy.

Extended capacities, kW

Liquid / Condensing temperature °C	R 22 / R 407C	R 134a	R 404A / R 507	Valve type
60 bubble point for all refrigerants (64 dew point for R407C)	7	4.9	5.8	EX4
	23	16	19	EX5
	54	38	45	EX6
	191	135	161	EX7
	581	411	488	EX8
50 bubble point for all refrigerants (54 dew point for R407C)	6.1	4.3	5.5	EX4
	20	14	18	EX5
	46	32	41	EX6
	163	115	147	EX7
	495	348	447	EX8
40 bubble point for all refrigerants (45 dew point for R407C)	4.9	3.7	4.9	EX4
	16	12	16	EX5
	38	27	36	EX6
	136	95	130	EX7
	414	289	394	EX8
30 bubble point for all refrigerants (35 dew point for R407C)	4.3	2.8	4	EX4
	14	9	13	EX5
	32	22	31	EX6
	112	78	111	EX7
	340	236	336	EX8

EX6/EX7/EX8 Nominal and extended capacities as suction pressure regulator (evaporator or crankcase)

Nominal Capacities, kW

Valve Type	Kv, m ³ /h	R 407C	R 22	R 134a	R 404A
EX6	1.57	3.9	4.1	3.1	3.5
EX7	5.58	14	15	11	13
EX8	16.95	42	45	34	38

The nominal capacity (Qn) is based on the following conditions:

Refrigerant	Evaporating temperature	Condensing temperature	Subcooling	Pressure Drop
R 22, R 134a, R 404A	+4°C	+38°C	1K	0.15 bar
R 407C	+4°C dew point	+38°C bubble / +43°C dew point	1K	0.15 bar

Remarks: Bi-flow versions are not released for use below -40°C.

EX6, EX7 and EX8 must be installed with motor downward in suction line applications.

This insures the valve life expectancy.

Multiply above nominal capacities by following factors to obtain capacities at different pressure drops:

ΔP, bar	0.10	0.15	0.20	0.30
Correction factor	0.82	1.00	1.15	1.41

Example: EX6 provides 3.5 kW at 0.15 bar pressure drop with R404A: 3.5*1.41 = 4.9 kW capacity at 0.3 bar pressure drop.

Extended capacities in kW, suction pressure regulator duty

Condensing temperature °C	R 22 Extended capacity kW							Valve type
	Evaporating temperature °C							
	10	5	0	-10	-20	-30	-40	
60	4	3	3	3	2	2	1	EX6
	13	12	11	9	7	5	4	EX7
	41	37	34	27	22	17	12	EX8
50	4	4	3	3	2	2	1	EX6
	15	13	12	10	8	6	5	EX7
	45	41	37	30	24	19	14	EX8
40	5	4	4	3	2	2	1	EX6
	16	15	13	11	9	7	5	EX7
	49	45	41	33	27	21	15	EX8
30	5	4	4	3	3	2	2	EX6
	17	16	14	12	9	7	5	EX7
	53	48	44	36	29	22	16	EX8
20	5	5	4	4	3	2	2	EX6
	19	17	15	13	10	8	6	EX7
	56	52	47	39	31	24	18	EX8

Condensing temperature Dew point °C	Bubble point °C	R 407C Extended capacity kW					Valve type
		Evaporating temperature °C					
		10	5	0	-10	-20	
64	60	3	3	3	2	2	EX6
		12	11	10	8	6	EX7
		36	33	29	23	18	EX8
54	50	4	3	3	2	2	EX6
		14	12	11	9	7	EX7
		41	37	34	27	21	EX8
45	40	4	4	3	3	2	EX6
		15	14	12	10	8	EX7
		46	42	38	30	23	EX8
35	30	5	4	4	3	2	EX6
		17	15	14	11	9	EX7
		51	46	41	33	26	EX8
26	20	5	5	4	3	3	EX6
		18	16	15	12	9	EX7
		55	50	45	36	28	EX8

Extended capacities in kW, suction pressure regulator duty

Condensing temperature °C	R 134a Extended capacity kW					Valve type
	Evaporating temperature °C					
	10	5	0	-10	-20	
60	3	2	2	2	1	EX6
	10	9	8	6	4	EX7
	30	27	24	18	13	EX8
50	3	3	2	2	1	EX6
	11	10	9	7	5	EX7
	34	30	27	21	15	EX8
40	3	3	3	2	2	EX6
	12	11	10	8	6	EX7
	38	34	30	23	17	EX8
30	4	3	3	2	2	EX6
	14	12	11	8	6	EX7
	41	37	33	26	19	EX8
20	4	4	3	3	2	EX6
	15	13	12	9	7	EX7
	45	40	36	28	21	EX8

Condensing temperature °C	R 404A / R 507 Extended capacity kW							Valve type
	Evaporating temperature °C							
	10	5	0	-10	-20	-30	-40	
60	3	2	2	2	1	1	1	EX6
	9	8	8	6	4	3	2	EX7
	29	26	23	18	13	10	7	EX8
50	3	3	3	2	2	1	1	EX6
	12	11	9	7	6	4	3	EX7
	36	32	29	23	18	13	9	EX8
40	4	3	3	3	2	1	1	EX6
	14	12	11	9	7	5	4	EX7
	42	38	34	27	21	16	12	EX8
30	4	4	4	3	2	2	1	EX6
	16	14	13	10	8	6	5	EX7
	48	43	39	31	25	19	14	EX8
20	5	4	4	3	3	2	1	EX6
	17	16	14	12	9	7	5	EX7
	53	48	44	35	28	21	16	EX8

EX5/EX6/EX7/EX8 Nominal and extended capacities as condensing pressure regulator and liquid duty

Nominal Capacities, kW

Valve Type	Kv, m ³ /h	R 407C	R 22	R 134a	R 404A
EX5	0.68	18	20	18	13
EX6	1.57	43	46	42	30
EX7	5.58	153	162	151	106
EX8	16.95	463	491	458	323

The nominal capacity (Qn) is based on the following conditions:

Refrigerant	Evaporating temperature	Condensing temperature	Subcooling	Pressure Drop
R 22, R 134a, R 404A	+4°C	+38°C	1K	0.35 bar
R 407C	+4°C dew point	+38°C bubble / +43°C dew point	1K	0.35 bar

Multiply above nominal capacities by following factors to obtain capacities at different pressure drops.

ΔP, bar	0.15	0.20	0.35
Correction factor	0.65	0.76	1.00

Extended capacities, kW

Condensing temperature °C	R 22 Extended capacity kW						Valve type
	Evaporating temperature °C						
	10	0	-10	-20	-30	-40	
60	15	15	15	14	14	13	EX5
	36	35	34	33	32	30	EX6
	128	124	120	116	112	108	EX7
	387	377	365	353	341	328	EX8
50	17	17	16	17	16	15	EX5
	41	40	36	39	36	35	EX6
	144	141	129	137	129	124	EX7
	439	428	391	416	391	377	EX8
40	19	19	19	18	17	17	EX5
	45	44	43	42	41	39	EX6
	161	157	153	149	145	140	EX7
	488	477	465	453	439	426	EX8
30	21	21	20	20	19	19	EX5
	50	49	48	46	45	44	EX6
	177	173	169	165	160	156	EX7
	536	525	513	500	486	472	EX8
20	23	23	22	22	21	21	EX5
	54	53	52	51	49	48	EX6
	192	188	184	180	175	171	EX7
	584	572	560	547	533	519	EX8

Condensing temperature °C	R 134a Extended capacity kW				Valve type
	Evaporating temperature °C				
	10	0	-10	-20	
60	14	13	13	12	EX5
	32	31	29	27	EX6
	115	109	104	98	EX7
	350	332	315	296	EX8
50	16	15	15	14	EX5
	37	36	34	32	EX6
	133	127	121	115	EX7
	405	387	369	350	EX8
40	18	18	17	16	EX5
	42	41	39	37	EX6
	151	145	139	133	EX7
	458	440	422	403	EX8
30	20	20	19	18	EX5
	47	46	44	42	EX6
	168	162	156	150	EX7
	512	493	474	455	EX8
20	22	22	21	20	EX5
	52	51	49	47	EX6
	186	180	173	167	EX7
	564	546	526	507	EX8

D A T A S H E E T

Extended capacities in kW, condensing pressure and liquid regulator

Condensing temperature °C	Extended capacity kW						Valve type
	R 404A / R507 Evaporating temperature °C						
	10	0	-10	-20	-30	-40	
60	8	8	7	6	6	5	EX5
	19	17	16	15	13	12	EX6
	66	62	58	53	48	43	EX7
	202	189	175	160	146	130	EX8
50	11	10	9	9	8	8	EX5
	24	23	22	20	19	17	EX6
	87	82	78	73	67	62	EX7
	264	250	236	220	205	189	EX8
40	13	12	12	11	10	10	EX5
	30	28	27	26	24	23	EX6
	106	101	96	91	85	80	EX7
	321	306	291	276	260	243	EX8
30	15	14	14	13	12	12	EX5
	35	33	32	30	29	27	EX6
	123	119	114	108	103	97	EX7
	375	360	345	329	312	295	EX8
20	17	16	16	15	14	14	EX5
	40	38	37	35	34	32	EX6
	141	136	131	125	120	114	EX7
	427	412	397	380	363	346	EX8

Condensing temperature Dew point °C	Bubble point °C	Extended capacity kW				Valve type
		R 407C Evaporating temperature °C				
		10	0	-10	-20	
64	60	14	13	12	12	EX5
		32	30	29	28	EX6
		112	108	103	98	EX7
		340	327	313	298	EX8
54	50	16	15	15	14	EX5
		37	36	35	33	EX6
		132	128	123	118	EX7
		402	388	373	358	EX8
45	40	18	18	17	17	EX5
		43	41	40	38	EX6
		152	147	142	137	EX7
		460	446	431	415	EX8
35	30	21	20	19	19	EX5
		48	47	45	44	EX6
		170	166	160	155	EX7
		517	503	487	471	EX8
26	20	23	22	22	21	EX5
		53	52	50	49	EX6
		189	184	179	173	EX7
		573	558	543	526	EX8

D A T A S H E E T

EX6/EX7/EX8 Nominal and extended capacities for hot gas flow such as heat reclaim application

Nominal Capacities, kW

Valve Type	Kv, m ³ /h	R 22 / R 407C	R 134a	R 404° / R 507	R 410A
EX6	1.57	11	9	10	13
EX7	5.58	39	33	36	47
EX8	16.95	119	101	108	144

The nominal capacity (Qn) is based on the following conditions:

Refrigerant	Evaporating temperature	Condensing temperature	Subcooling	Pressure Drop	Isentropic Efficiency
R 22, R 134a, R 404A, R 507, R410A	+4°C	+38°C	1K	0.5 bar	80%
R 407C	+4°C dew point	+38°C bubble / +43°C dew point	1K	0.5 bar	80%

Remarks: Bi-flow versions are not released for hot gas flow applications.

EX6, EX7 and EX8 must be installed with motor downward in suction line applications.

This insures the valve life expectancy.

Extended capacities, kW

Condensing temperature °C	Pressure drop bar	Extended capacity kW														Valve Type
		R 404A														
		Evaporating temperature °C														
60	0.1	15	10	5	0	-5	-10	-15	-20	-25	-30	-35	-40	-45	EX6	
		4	4	4	4	4	3	3	3	3	3	3	2	2	EX7	
		15	14	14	13	13	12	11	11	10	10	9	8	8	EX8	
	0.5	45	43	42	40	38	36	35	33	31	29	27	25	23	EX6	
		9	9	8	8	8	7	7	7	6	6	6	5	5	EX7	
		32	31	30	29	28	26	25	24	22	21	20	18	17	EX8	
	1	99	95	92	88	84	80	76	72	68	64	60	56	52	EX6	
		13	12	12	11	11	10	10	9	9	8	8	7	7	EX7	
		45	44	42	40	39	37	35	33	31	29	27	26	24	EX8	
50	0,1	137	132	127	122	117	112	106	101	95	89	84	78	72	EX6	
		5	4	4	4	4	4	4	4	3	3	3	3	3	EX7	
		16	16	15	15	14	14	13	13	12	11	11	10	10	EX8	
	0.5	49	47	46	44	43	41	40	38	36	35	33	31	30	EX6	
		10	10	9	9	9	8	8	8	7	7	7	6	6	EX7	
		35	34	33	32	31	30	29	28	26	25	24	23	22	EX8	
	1	107	104	101	98	95	91	88	84	80	77	73	69	65	EX6	
		14	13	13	13	12	12	11	11	10	10	9	9	8	EX7	
		49	48	46	45	43	42	40	38	37	35	33	32	30	EX8	
40	0.1	149	145	141	136	131	127	122	117	112	107	102	96	91	EX6	
		5	4	4	4	4	4	4	4	4	3	3	3	3	EX7	
		16	16	16	15	15	14	14	13	13	12	12	11	11	EX8	
	0.5	50	49	47	46	45	43	42	40	39	37	36	34	33	EX6	
		10	10	10	9	9	9	9	8	8	8	7	7	7	EX7	
		36	35	34	33	32	31	30	29	28	27	26	25	24	EX8	
	1	109	107	104	101	98	95	92	89	86	83	79	76	73	EX6	
		14	14	13	13	13	12	12	11	11	11	10	10	9	EX7	
		50	49	48	46	45	44	42	41	39	38	36	35	33	EX8	
30	0.1	152	148	144	140	136	132	128	124	119	115	110	105	101	EX6	
		5	4	4	4	4	4	4	4	4	4	3	3	3	EX7	
		16	16	15	15	15	14	14	13	13	13	12	12	11	EX8	
	0.5	49	48	47	46	45	43	42	41	40	38	37	36	34	EX6	
		10	10	10	9	9	9	9	8	8	8	8	7	7	EX7	
		35	35	34	33	32	31	31	30	29	28	27	26	25	EX8	
	1	108	105	103	101	98	95	93	90	87	84	81	78	76	EX6	
		14	13	13	13	13	12	12	12	11	11	10	10	10	EX7	
		49	48	47	46	45	43	42	41	40	38	37	36	34	EX8	
1	149	146	142	139	135	132	128	124	120	117	113	109	104	EX6		
	14	13	13	13	13	12	12	12	11	11	10	10	10	EX7		
	49	48	47	46	45	43	42	41	40	38	37	36	34	EX8		

Extended capacities kW, hot gas flow such as heat reclaim applications

Condensing temperature °C	Pressure drop bar	Extended capacity kW													Valve Type
		R 134a													
		Evaporating temperature °C													
		15	10	5	0	-5	-10	-15	-20	-25	-30	-35	-40	-45	
60	0.1	5	5	4	4	4	4	4	4	4	3	3	3	3	EX6
		16	16	16	15	15	14	14	13	13	12	12	11	10	EX7
		50	49	47	46	44	43	41	40	38	37	35	33	32	EX8
	0.5	10	10	10	9	9	9	8	8	8	7	7	7	6	EX6
		36	35	34	33	32	31	30	29	28	26	25	24	23	EX7
		110	107	104	101	97	94	91	87	84	80	77	74	70	EX8
	1	14	14	13	13	12	12	12	11	11	10	10	9	9	EX6
		50	49	47	46	44	43	41	40	38	37	35	34	32	EX7
		152	148	144	139	135	130	126	121	116	112	107	102	97	EX8
50	0.1	5	4	4	4	4	4	4	4	4	3	3	3	3	EX6
		16	16	15	15	14	14	14	13	13	12	12	11	11	EX7
		49	48	47	45	44	43	41	40	39	37	36	35	33	EX8
	0.5	10	10	9	9	9	9	8	8	8	8	7	7	7	EX6
		35	35	34	33	32	31	30	29	28	27	26	25	24	EX7
		108	105	102	99	97	94	91	88	85	82	79	76	73	EX8
	1	14	13	13	13	12	12	12	11	11	10	10	10	9	EX6
		49	48	46	45	44	43	41	40	39	37	36	34	33	EX7
		148	145	141	137	133	129	125	121	117	113	109	105	100	EX8
40	0.1	4	4	4	4	4	4	4	4	4	3	3	3	3	EX6
		16	15	15	14	14	14	13	13	13	12	12	11	11	EX7
		47	46	45	44	43	42	40	39	38	37	36	34	33	EX8
	0.5	10	9	9	9	9	8	8	8	8	7	7	7	7	EX6
		34	33	32	32	31	30	29	28	27	26	26	25	24	EX7
		103	100	98	96	93	91	88	86	83	80	78	75	73	EX8
	1	13	13	12	12	12	12	11	11	11	10	10	10	9	EX6
		46	45	44	43	42	41	40	39	38	36	35	34	33	EX7
		141	138	134	131	128	124	121	117	114	110	107	103	100	EX8
30	0.1	4	4	4	4	4	4	4	3	3	3	3	3	3	EX6
		15	14	14	14	13	13	13	12	12	12	11	11	11	EX7
		44	43	42	42	41	40	39	38	37	35	34	33	32	EX8
	0.5	9	9	9	8	8	8	8	8	7	7	7	7	6	EX6
		32	31	30	30	29	28	28	27	26	25	25	24	23	EX7
		96	94	92	90	88	86	84	81	79	77	75	72	70	EX8
	1	12	12	12	11	11	11	11	10	10	10	9	9	9	EX6
		43	42	41	40	39	38	37	36	35	34	33	32	31	EX7
		130	128	125	122	119	117	114	111	108	105	102	98	95	EX8

Extended capacities kW, hot gas flow such as heat reclaim applications

Condensing temperature °C	Pressure drop bar	Extended capacity kW													Valve Type
		R 22 / R 407C* Evaporating temperature °C													
		15	10	5	0	-5	-10	-15	-20	-25	-30	-35	-40	-45	
60	0.1	6	5	5	5	5	5	5	5	4	4	4	4	4	EX6
		20	19	19	18	18	17	17	16	16	15	15	14	14	EX7
		59	58	57	55	54	53	51	50	48	47	45	44	42	EX8
	0.5	12	12	12	11	11	11	10	10	10	10	9	9	9	EX6
		43	42	41	40	39	38	37	36	35	34	33	32	31	EX7
		131	129	126	123	119	116	113	110	107	103	100	97	94	EX8
	1	17	17	16	16	15	15	15	14	14	14	13	13	13	EX6
		60	59	58	56	55	53	52	51	49	48	46	45	43	EX7
		183	179	175	171	167	162	158	154	149	145	140	135	131	EX8
50	0.1	5	5	5	5	5	5	5	5	4	4	4	4	4	EX6
		19	19	18	18	17	17	17	16	16	15	15	14	14	EX7
		58	57	56	54	53	52	51	49	48	47	45	44	42	EX8
	0.5	12	12	11	11	11	11	10	10	10	10	9	9	9	EX6
		42	41	40	40	39	38	37	36	35	34	33	32	31	EX7
		128	126	123	120	117	115	112	109	106	103	100	97	94	EX8
	1	17	16	16	15	15	15	14	14	14	13	13	13	12	EX6
		59	57	56	55	54	52	51	50	49	47	46	44	43	EX7
		178	175	171	167	163	159	155	151	147	143	139	135	131	EX8
40	0.1	5	5	5	5	5	5	5	4	4	4	4	4	4	EX6
		18	18	18	17	17	16	16	16	15	15	15	14	14	EX7
		56	55	54	52	51	50	49	48	47	45	44	43	42	EX8
	0.5	11	11	11	11	10	10	10	10	9	9	9	9	8	EX6
		40	40	39	38	37	36	35	35	34	33	32	31	30	EX7
		123	120	118	115	113	110	108	105	103	100	97	94	92	EX8
	1	16	15	15	15	14	14	14	14	13	13	12	12	12	EX6
		56	55	54	53	52	50	49	48	47	46	44	43	42	EX7
		170	167	163	160	157	153	149	146	142	139	135	131	127	EX8
30	0.1	5	5	5	5	4	4	4	4	4	4	4	4	4	EX6
		17	17	17	16	16	16	15	15	15	14	14	14	13	EX7
		53	52	51	50	49	48	46	45	44	43	42	41	40	EX8
	0.5	11	10	10	10	10	10	9	9	9	9	9	8	8	EX6
		38	37	37	36	35	34	34	33	32	31	30	30	29	EX7
		115	113	111	109	107	104	102	100	97	95	93	90	88	EX8
	1	15	14	14	14	14	13	13	13	12	12	12	12	11	EX6
		52	51	50	49	48	47	46	45	44	43	42	41	40	EX7
		159	156	153	150	147	144	141	138	134	131	128	124	121	EX8

*) Condensing temperatures R 407C:

The relation between bubble points and dew points is as follows:

Bubble point °C	Dew point °C
60	64
50	54
40	45
30	35

Extended capacities kW, hot gas flow such as heat reclaim applications

Condensing temperature °C	Pressure drop bar	Extended capacity kW													Valve Type
		R 410A													
		Evaporating temperature °C													
		15	10	5	0	-5	-10	-15	-20	-25	-30	-35	-40	-45	
60	0.1	6	6	6	6	5	5	5	5	5	5	4	4	4	EX6
		21	21	20	20	19	19	18	18	17	16	16	15	15	EX7
		64	63	62	60	58	57	55	53	52	50	48	46	44	EX8
	0.5	13	13	13	12	12	12	11	11	11	10	10	10	9	EX6
		47	46	45	44	43	41	40	39	38	36	35	34	32	EX7
		143	140	137	133	130	126	122	118	115	111	107	103	99	EX8
	1	19	18	18	17	17	16	16	15	15	14	14	13	13	EX6
		66	64	63	61	60	58	56	55	53	51	49	47	46	EX7
		200	196	191	186	182	177	171	166	161	155	150	144	138	EX8
50	0.1	6	6	6	6	6	6	5	5	5	5	5	5	4	EX6
		22	22	21	21	20	20	19	19	18	18	17	17	16	EX7
		67	66	65	63	62	60	59	57	55	54	52	50	48	EX8
	0.5	14	14	13	13	13	12	12	12	11	11	11	10	10	EX6
		49	48	47	46	45	44	43	42	40	39	38	37	35	EX7
		149	146	143	140	137	133	130	126	123	119	115	111	108	EX8
	1	19	19	19	18	18	17	17	16	16	15	15	14	14	EX6
		69	67	66	64	63	61	60	58	57	55	53	51	50	EX7
		209	204	200	196	191	186	182	177	172	167	161	156	151	EX8
40	0.1	6	6	6	6	6	6	5	5	5	5	5	5	5	EX6
		22	22	21	21	20	20	19	19	18	18	17	17	16	EX7
		67	66	65	63	62	60	59	57	55	54	52	50	48	EX8
	0.5	14	13	13	13	13	12	12	12	11	11	11	11	10	EX6
		49	48	47	46	45	44	43	42	41	40	39	37	36	EX7
		148	146	143	140	137	134	131	127	124	121	117	114	110	EX8
	1	19	19	18	18	18	17	17	16	16	16	15	15	14	EX6
		68	67	66	64	63	61	60	59	57	55	54	52	51	EX7
		207	203	199	195	191	187	182	178	173	168	164	159	154	EX8
30	0.1	6	6	6	6	6	5	5	5	5	5	5	5	5	EX6
		21	21	21	20	20	19	19	19	18	18	17	17	16	EX7
		65	64	63	61	60	59	58	56	55	53	52	51	49	EX8
	0.5	13	13	13	13	12	12	12	12	11	11	11	10	10	EX6
		47	46	45	45	44	43	42	41	40	39	38	37	36	EX7
		143	141	138	135	133	130	127	124	121	118	115	112	109	EX8
	1	18	18	18	17	17	17	16	16	16	15	15	14	14	EX6
		65	64	63	62	61	60	58	57	56	54	53	51	50	EX7
		199	195	192	188	185	181	177	173	169	165	160	156	152	EX8

Application of control valves in systems

The following schematics show the arrangement of integrated valves for different applications.

Legends:

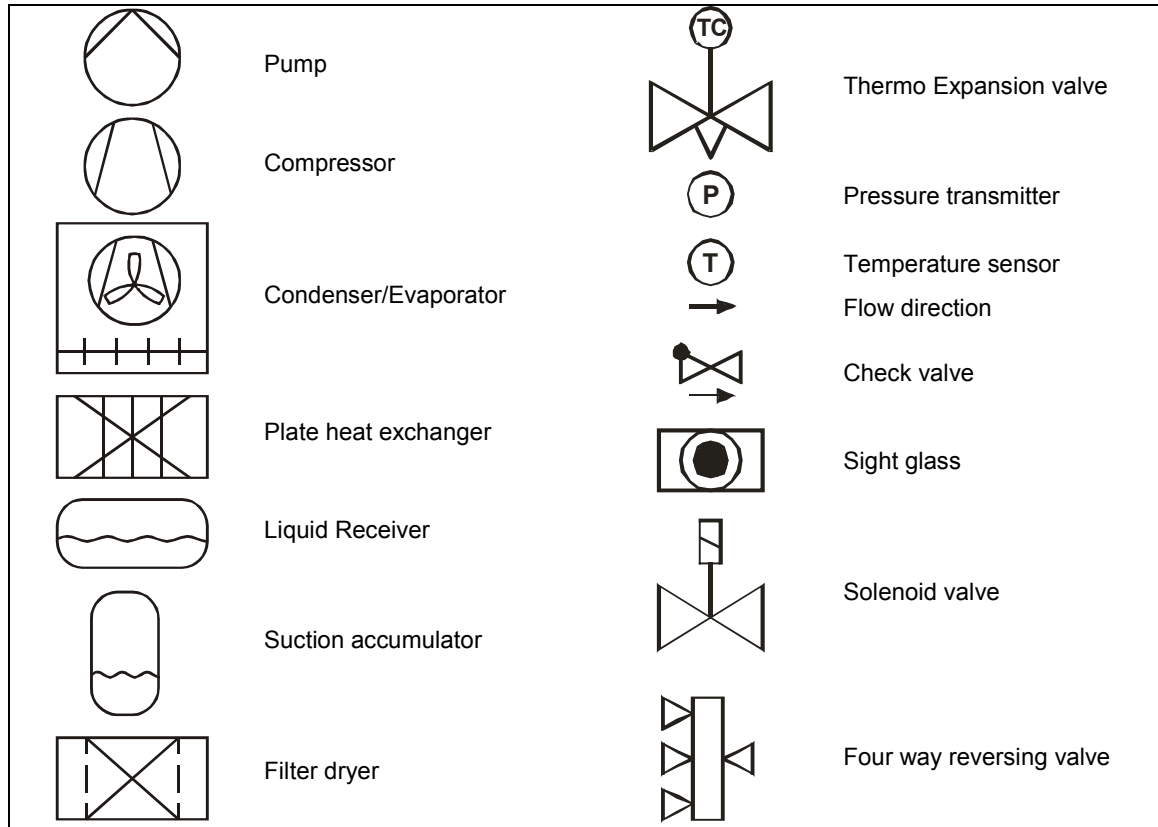

Overview applications:

	page
Application 1: Expansion valve in cooling system	22
Application 2: Bi-Flow expansion valve in heat pump (except EX8)	22
Application 3: Expansion valve in heat pump (one valve)	23
Application 4: Expansion valve in heat pump (two valves)	23
Application 5: Expansion valve as liquid injection valve for desuperheating	24
Application 6: Expansion valve as liquid injection valve for subcooling	24
Application 7: Capacity control by means of hot gas bypass	25
Application 8: Capacity control by means of suction pressure throttling	25
Application 9: Crankcase pressure control	26
Application 10: Head pressure control	26
Application 11: Liquid level control	27

Application 1: Expansion valve in cooling system

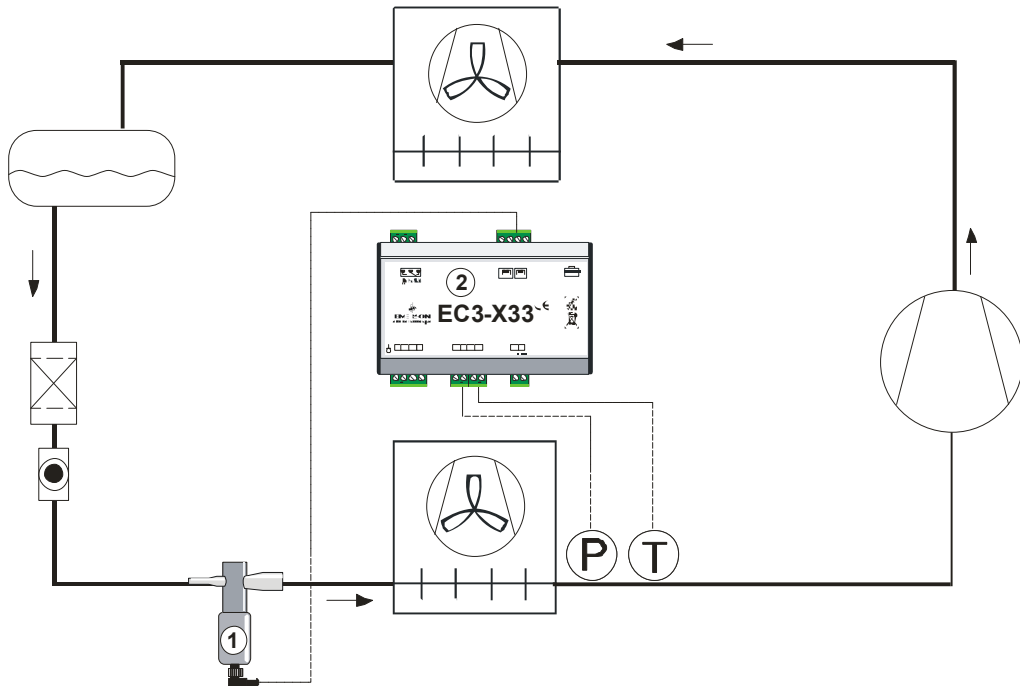

- (1) = Expansion Valve
- (2) = Superheat controller EC3-X33

Application 2: Bi-Flow expansion valve in heat pump (except EX8)

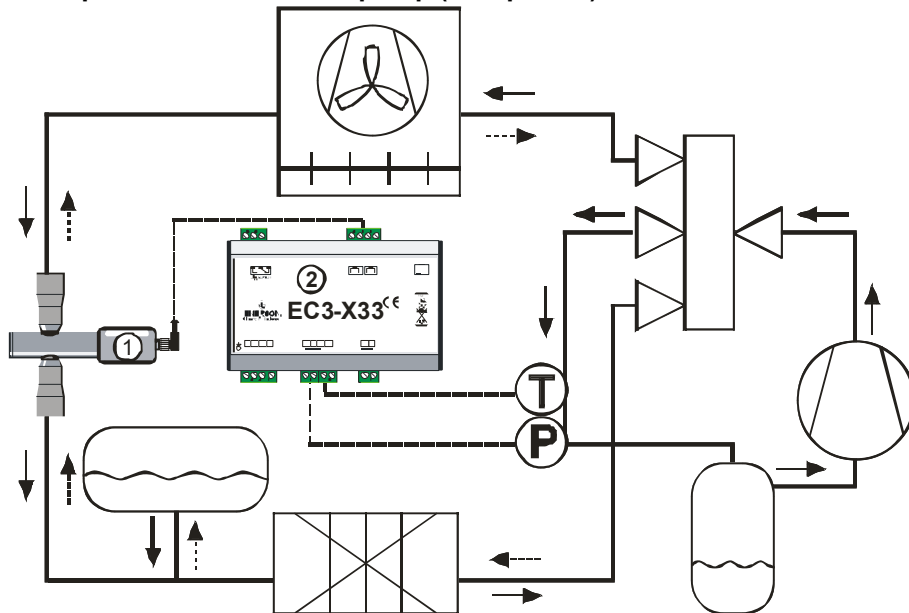

- (1) = Bi-Flow Expansion Valve
- (2) = Superheat controller EC3-X33

Application 3: Expansion valve in heat pump (one valve)

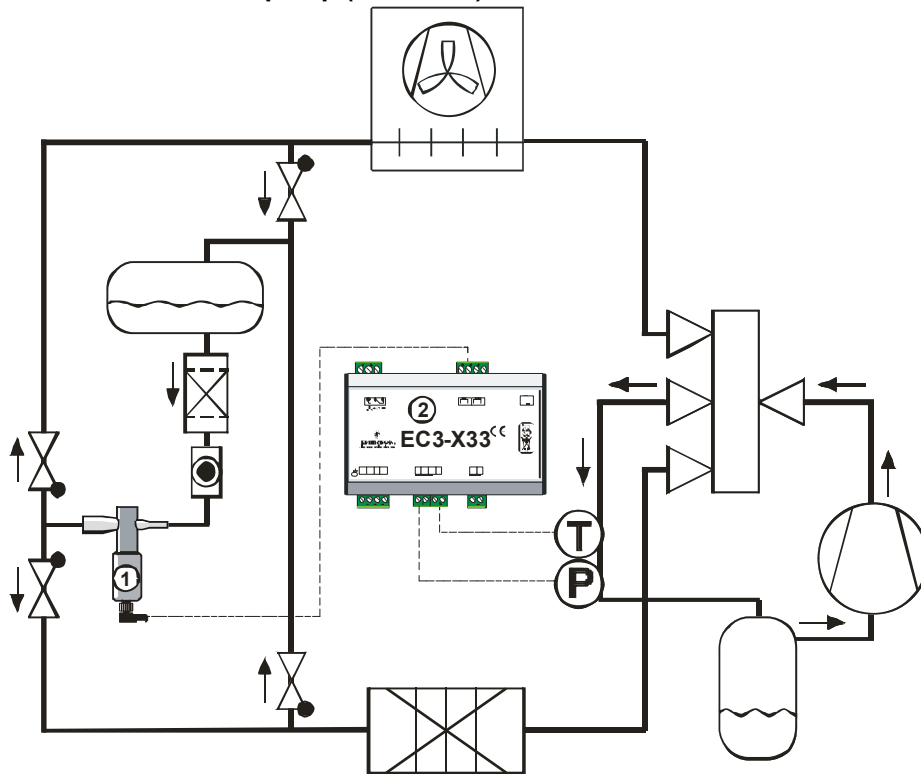

- (1) = Expansion Valve
- (2) = Superheat controller EC3-X33

Application 4: Expansion valve in heat pump (two valves)

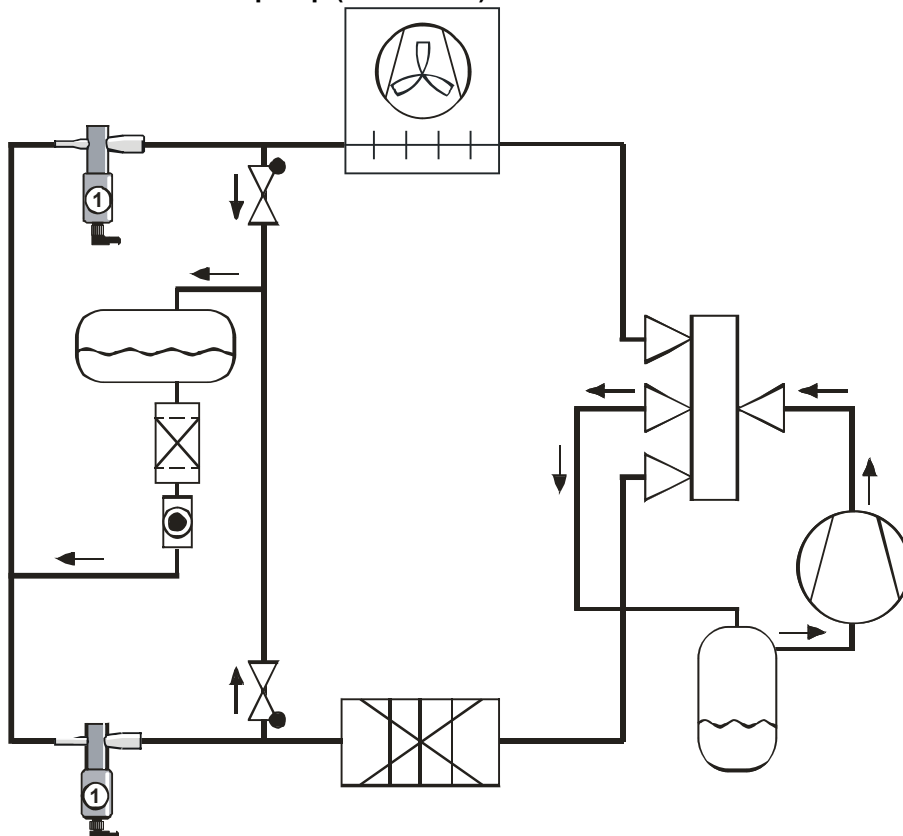

- (1) = Expansion Valve, heating mode
- (2) = Expansion Valve, cooling mode

Application 5: Expansion valve as liquid injection valve for desuperheating

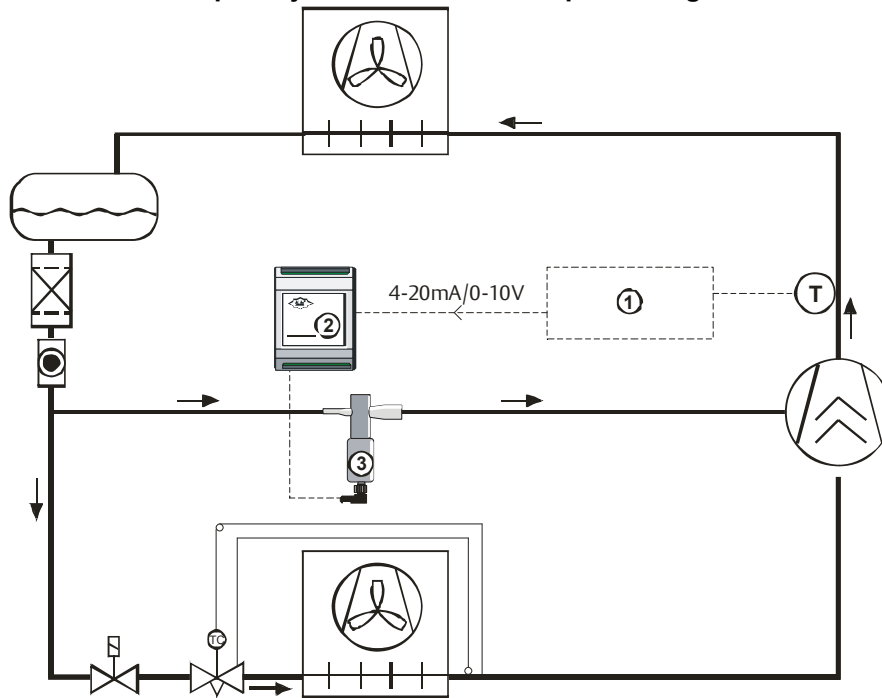

- (1) = Temperature Controller
- (2) = Stepper motor driver EXD-U00
- (3) = Electrical Control Valve

Application 6: Expansion valve as liquid injection valve for subcooling

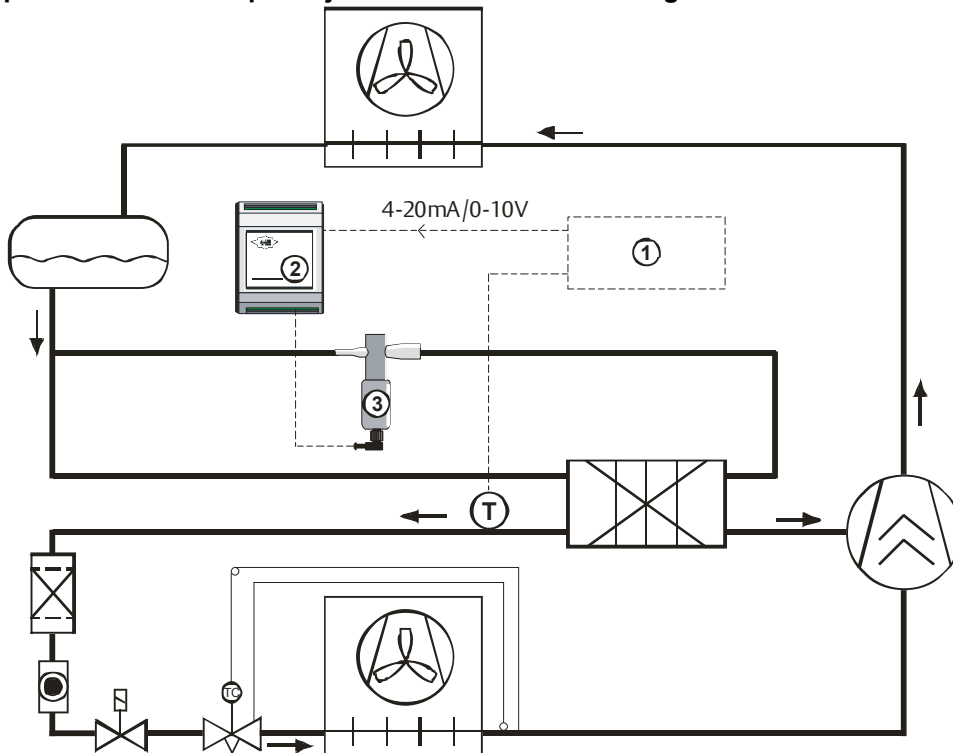

- (1) = Temperature Controller
- (2) = Stepper motor driver EXD-U00
- (3) = Electrical Control Valve

Application 7: Capacity control by means of hot gas bypass

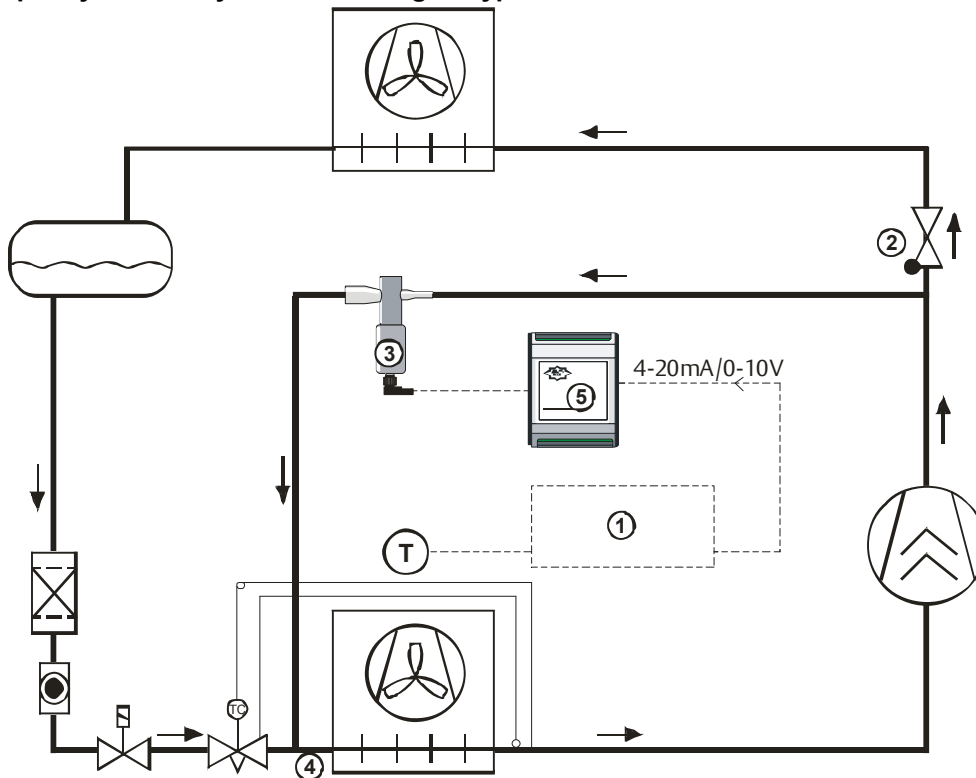

Remarks:

(1) = Temperature Controller

(2) = Check Valve: It is important to install a check valve just after T-connection as shown. Check valve will not allow return of liquid refrigerant from condenser through electrical control valve in to the evaporator during power interruption to system.

(3) = Hot gas bypass valve must be installed with motor downward. This insures the valve life expectancy.

(4) = Liquid Distributor must be selected properly for hot gas mass flow.

(5) = Stepper motor driver EXD-U00

Application 8: Capacity control by means of suction pressure throttling

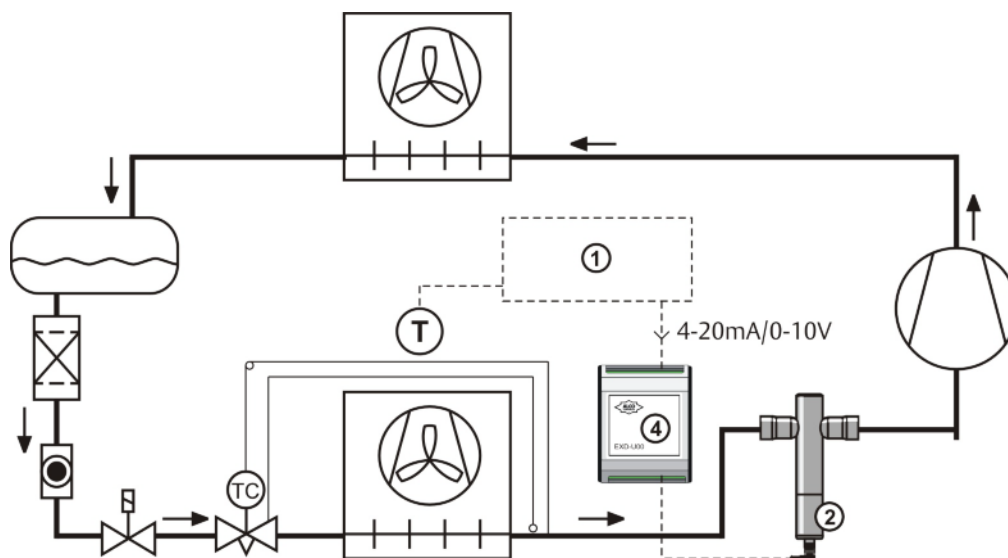

Remarks:

(1) = Temperature Controller

(2) = Evaporator temperature regulator. EX6, EX7 and EX8 must be installed with motor downward in suction line applications. This insures the valve life expectancy.

(3) This application may require additional liquid injection to suction line for desuperheating of compressor by means of suction line superheat control or discharge line temperature control. Please consult Alco Controls for more details.

(4) = Stepper motor driver EXD-U00

Application 9: Crankcase pressure control

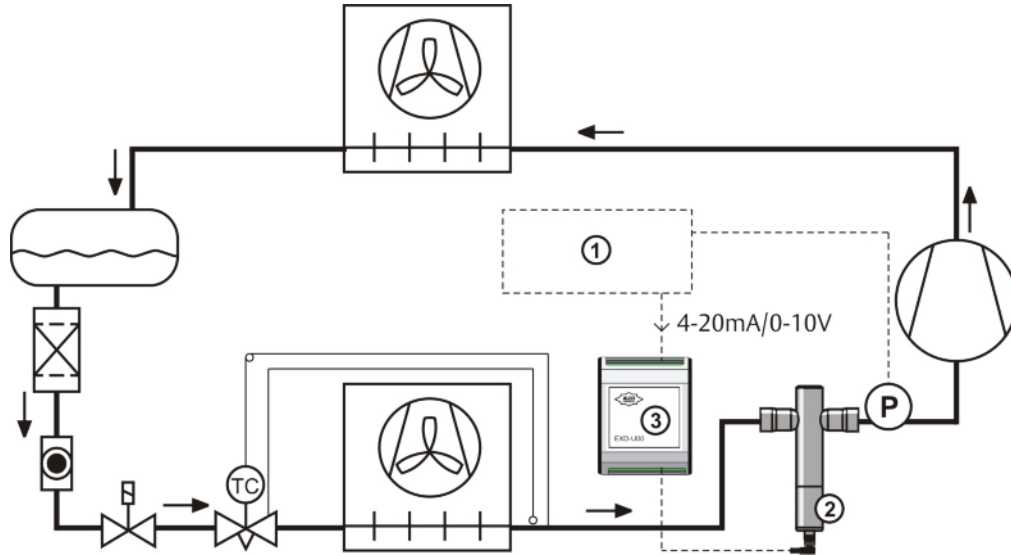

Remarks:

(1) = Pressure Controller

(3) = Stepper motor driver EXD-U00

(2) = Crankcase pressure regulator. ECVs must be installed with motor downward in suction line applications. This insures the valve life expectancy.

Application 10: Head pressure control

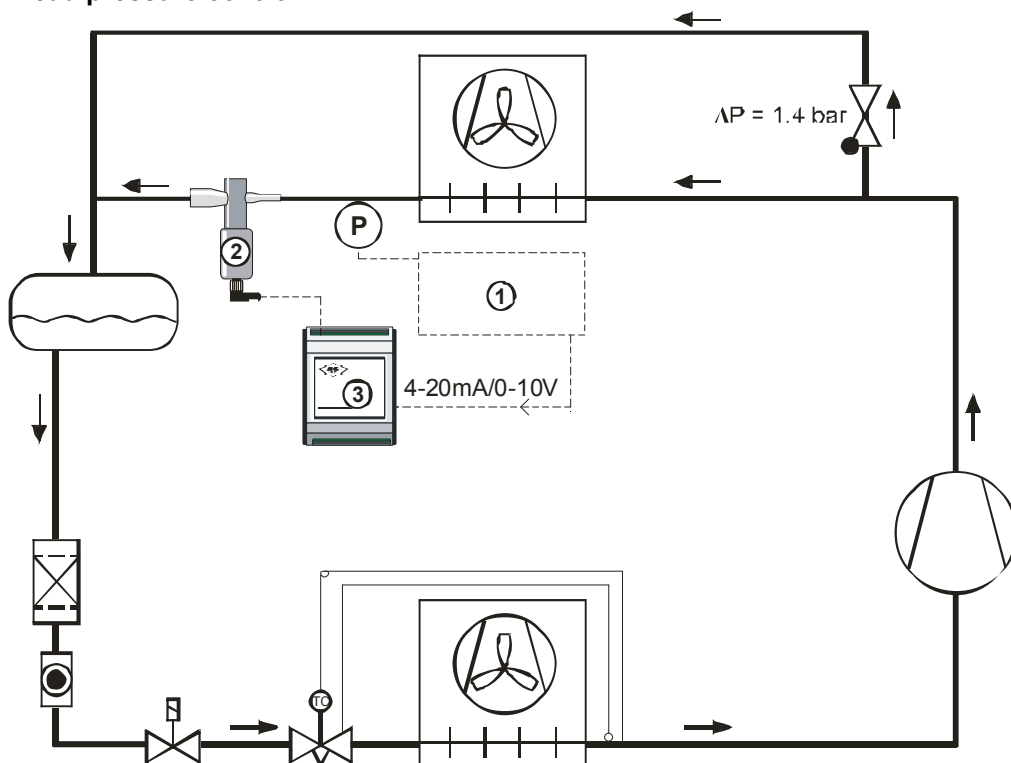

(1) = Pressure Controller

(2) = Condensing pressure regulator

(3) = Stepper motor driver EXD-U00

Application 11: Liquid level control

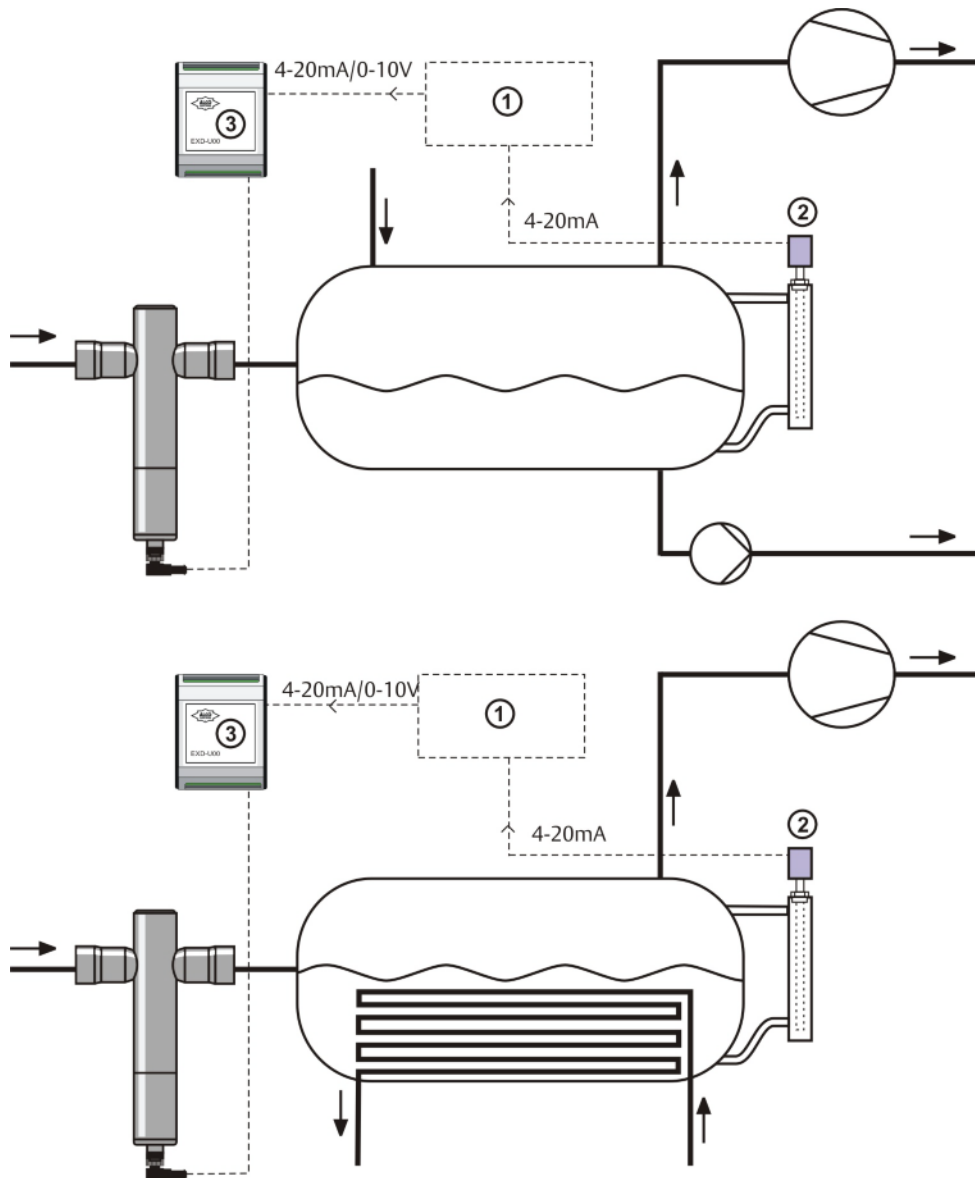

- (1) = Level Controller
- (2) = Liquid level sensor
- (3) = Stepper motor driver EXD-U00

Note: ECVs are not released for use with ammonia.

Driver and controller

In contrary to thermo-expansion and regulator valves, stepper motor driven valves are not self operated actuators and require:

- a stepper motor driver which generates the digital pulse sequence needed to move the stepper motor in clockwise or counter clockwise direction
- an algorithm which determines the opening of the valve as a function of system parameters and conditions.

EMERSON offers several solutions for this task:

EC3-X33 Superheat controller as stand alone for all applications and **EC3-X32 Superheat controller** for use in TCP/IP networks. The modules contain all required algorithms for full operation of ALCO ECVs. For further details please refer to EC3X33 or EC3X32 technical data sheet.

EC3-33x Cold Room Controller is a digital temperature controller primary for refrigeration applications such as cold rooms. It features temperature control, superheat control and defrost, compressor and fan management where applicable. For further details please refer to EC33x technical data sheet.

EXD-U Universal driver is a stepper motor driver which uses an analogue input signal to define the valve opening. It enables the operation of EX4/EX5/EX6/EX7/EX8 as:

- Electronic expansion valve
- Capacity control by means of hot gas bypass or evaporating pressure regulator
- Crankcase pressure regulator
- Condenser pressure regulator
- Liquid level actuator
- Liquid injection valve

The input signal for the driver module can be 4...20mA or 0...10V. The output pulses provide the proportional opening/closing of EX4/EX5/EX6/EX7/EX8 and consequently the control of liquid or vapour refrigerant mass flow. The universal driver module can be connected to any controller which provides the analogue signal. This gives system manufacturers the extreme flexibility to use any desired controller in conjunction with the universal driver module to achieve different functionality. For further details please refer to EXD-U technical data sheet.

The patented valve control module **VCM** is a hybrid integrated circuit, which provides the superheat algorithm and the stepper motor driver to those customers, who want to integrate the valve control into their own system controller. This solution is mainly for OEMs having serial mass production systems.

The following information is for those customers who want to develop their own driver/controller/algorithms:

Function

1) Motor

A 2-phase bipolar stepper motor drives the EX4/5/6/7/8. This motor follows the basic operating characteristics of any stepper motor i.e. the motor will be held in position unless current pulses from a driver board initiate rotation in either direction. The direction of the rotation depends on the phase relationship of the current pulses, the amount of rotation is dependent on the number of pulses. One pulse will drive the motor one step i.e. the rotor will move by $\alpha=1.8^\circ$. Successive pulses will lead to continuous rotation.

The drive shaft of the rotor is connected to a spindle which transforms the rotation into linear motion of the valve slide.

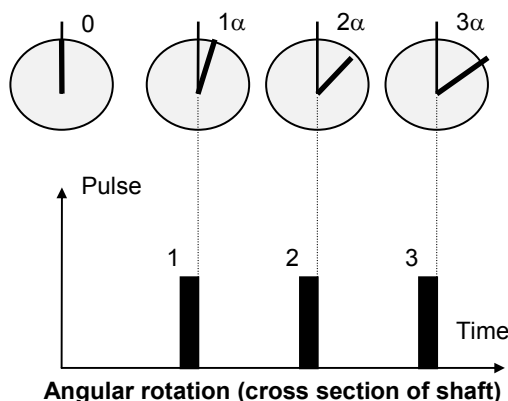

2) Valve

The gate type valve is optimised to provide a wide range of capacity with a linear relation between flow and positioning of the valve (capacity vs. number of steps). Slide and ports are made from ceramic for precise flow characteristics, high resolution and infinite life.

The compliant slide eliminates undesirable horizontal forces caused by differential pressure (across the valve) to the cage assembly and shaft of stepper motor. The internal design of the EX4/5/6/7/8 is patented.

Total valve travel is 750 full steps for EX4/5/6, 1600 steps for EX7 and 2600 steps for EX8.

A mechanical stop in the fully closed position of the valve acts as reference point. The controller is reset by driving the valve towards the fully closed position against the mechanical stop. By overdriving the valve i.e. applying more than the full number of steps, it can be assured that the reference point is correct.

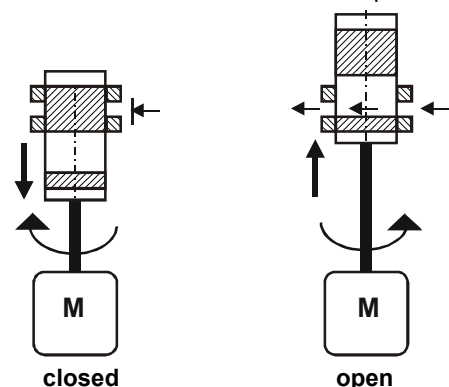

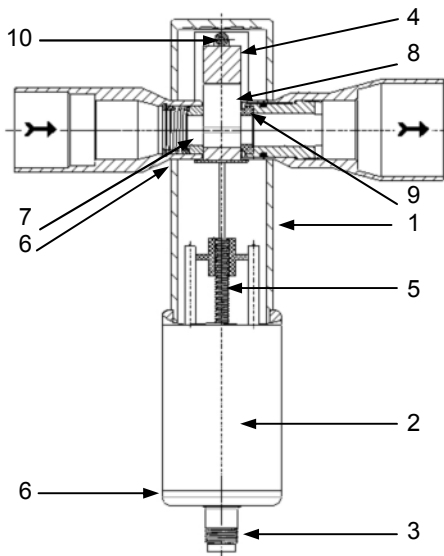

- 1 Stainless steel body
- 2 Stepper motor
- 3 Electrical connector
- 4 Cage assembly
- 5 Shaft
- 6 Welding and/or brazing
- 7 Ceramic inlet port
- 8 Ceramic slide
- 9 Ceramic outlet port
- 10 Bearing

3) Driving of stepper motor

There are many different options to drive stepper motors like the one used in the EX4/5/6/7/8. Alco Controls stepper motors need a driver board with chopper drive function (constant current), an interface and a controller.

Chopper drive (constant current)

The stepper motor of EX4/5/6/7/8 is a bipolar, 2-phase permanent-magnet motor and operates with constant DC current in each phase. A driver board with chopper drive function feeds a DC current as indicated below to the windings of the stepper motor.

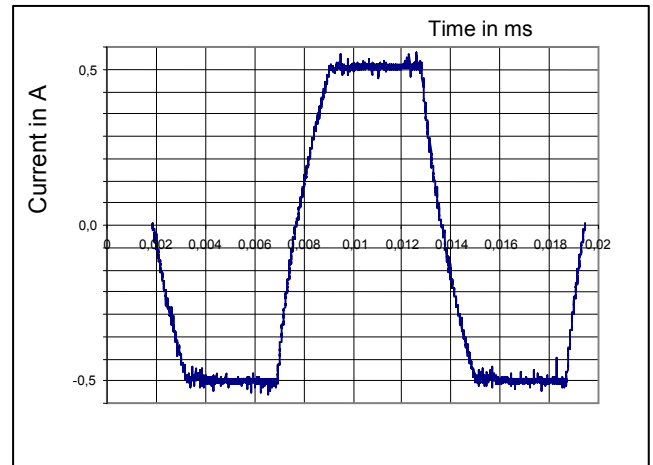

4) Design of customised driver board

A suitable driver board must be selected according to the electrical data of the stepper motor and based on the following requirements:

- Electrical output (four-stage switching sequence, see next page)
- Stepping rate: 500Hz for EX4/5/6/7/8
- Chopper function, current:

Current	EX4/5/6	EX7	EX8
Operating	500 mA	750 mA	800 mA
Holding	100 mA	250 mA	500 mA

Sequence for driving of stepper motor and valve

Direction	Reverse direction	Number of steps	Identification code of pins for electrical connections to third party drivers/controllers			
			A	B	C	D
			Current direction			
Valve is opening ↓	Valve is closing ↑	Step 1	+	-	+	-
		Step 2	-	+	+	-
		Step 3	-	+	-	+
		Step 4	+	-	-	+
		Remark	The sequence is repeated from step 5 to 8 similar to step 1 to 4			
		Step 5	+	-	+	-
		Step 6	-	+	+	-
		Step 7	-	+	-	+
		Step 8	+	-	-	+
		Remark	The sequence is repeated from step 9 to 12 similar to step 1 to 4			
↓	↓	↓	↓			

EX4/EX5/EX6/EX7/EX8 identification code of pins for electrical connection to third party drivers/controllers	M12 plug and cable assembly (EXV-Mxx) for EX4/EX5/EX6/EX7/EX8
	
	Cable, wire colour
A	White
B	Black
C	Blue
D	Brown

Technical data

CE marking EX4/EX5/EX6: EX7/EX8:	not required required, Cat I, Module A	Protection accordance to IEC 529, DIN 40050	IP67 with Alco supplied cable connector assembly
Compatibility (not released for use with inflammable refrigerants)	HCFCs, HFCs, CO ₂ Mineral and POE lubricants	Vibration for non-connected and fastened valve	4g (0 to 1000 Hz, 1 octave /min.)
MOPD (maximum operating pressure differential)	EX4/EX5/EX6/EX7: 35 bar EX8: 30 bar	Shock	20g at 11 ms 80g at 1 ms
Max. working pressure, PS	45 bar	Net weight (kg)	0.5 kg (EX4), 0.52 kg (EX5), 0.60 kg (EX6), 1.1 kg (EX7), 1.5 kg (EX8)
Ambient temperature Storage temperature	-40 to +55°C -40 to +70°C	External leakage	≤ 3 gram / year
Medium temperature range Bi-flow version: Uni-flow version	TS: -40 to +80°C TS: -50 to +100°C	Seat leakage	Positive shut-off better than solenoid valves
Salt spray test	non-corrosion stainless steel body	Accessories	See table on page 2
Humidity	5 to 95% r.H.	Package and delivery (individual)	without electrical connector
Connections	ODF stainless steel fittings		

Electrical data

Stepper motor type	Bi-polar, phase current by chopper control (constant current)	Phase inductance	EX4/EX5/EX6: 30 mH ± 25% EX7: 20 mH ± 25% EX8: 22 mH ± 25%
Electrical connection	4 pin terminal via plug	Step mode	2 phase full step
Recomm. driver supply voltg.	24 VDC (nominal)	Step angle	1.8° per step ± 8%
Driver supply voltage range	18 ... 36 VDC	Total number of steps	EX4/EX5/EX6: 750 full steps EX7: 1600 full steps EX8: 2600 full steps
Phase current, operating	EX4/EX5/EX6: 500mA max, -10% EX7: 750mA ±10% EX8: 800mA ±10%	Stepping rate	500Hz
Holding current	EX4/EX5/EX6: 100mA EX7: 250mA EX8: 500mA	Winding resistance per phase	EX4/EX5/EX6: 13Ohm ±10% EX7: 8Ohm ±10% EX8: 6Ohm ±10%
Nominal input power per phase	EX4/EX5/EX6: 3.5W EX7/EX8: 5W	Full travel time	EX4/EX5/EX6: 1.5 seconds EX7: 3.2 seconds EX8: 5.2 seconds
		Reference position	Mechanical stop at fully close position

Dimensions EX4 / EX5 / EX6 / EX7

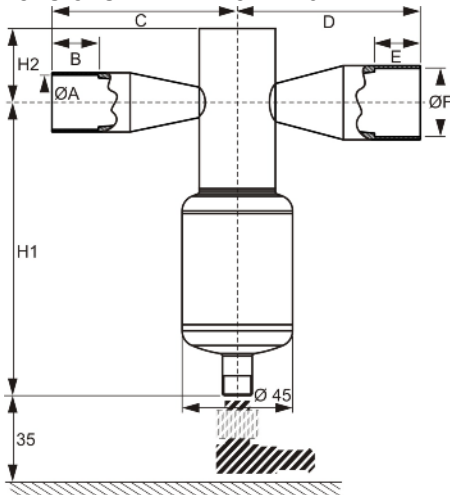

Dimensions EX8

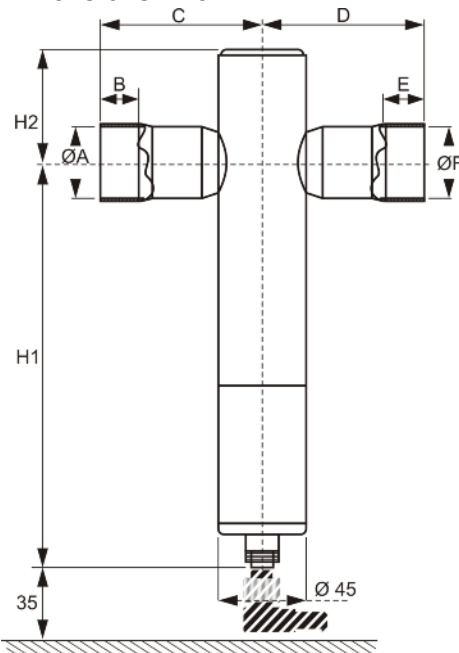

Valve Type	Ø A x Ø F (ODF)	B	C	D	E	H1	H2
EX4-I21	3/8" x 5/8"	8	45	55	11	113	25
EX4-M21	10 x 16 mm	8	45	55	11	113	25
EX4-U31	16 x 16 mm (5/8" x 5/8")	11	55	55	11	113	25
EX5-U21	5/8" x 7/8" (16 x 22 mm)	11	55	65	16	113	25
EX5-U31	7/8" x 7/8" (22 x 22 mm)	16	65	65	16	113	25
EX6-I21	7/8" x 1-1/8"	16	65	75	19	113	25
EX6-M21	22 x 28 mm	16	65	75	19	113	25
EX6-I31	1-1/8" x 1-1/8"	19	75	75	19	113	25
EX6-M31	28 x 28 mm	19	75	75	19	113	25
EX7-I21	1-1/8" x 1-3/8"	20	77.5	82.5	23	157	42
EX7-M21	28 x 35 mm	20	77.5	82.5	23	157	42
EX7-U31	1-3/8 x 1-3/8 (35 x 35 mm)	23	82.5	82.5	23	157	42
EX8-M21	42 x 42 mm	20	80	80	20	200	56
EX8-U21	1-3/8 x 1-3/8 (35 x 35 mm)	20	80	80	20	200	56
Ex8-I21	1-3/8 x 1-3/8	20	80	80	20	200	56

EMERSON is not to be held responsible for erroneous literature regarding capacities, dimensions, applications, etc. stated herein. Products, specifications and data in this literature are subject to change without notice. The information given herein is based on technical data and tests which EMERSON believes to be reliable and which are in compliance with technical knowledge of today. It is intended only for

use by persons having the appropriate technical knowledge and skills, at their own discretion and risk. Our products are designed and adapted for fixed locations. For mobile applications failures may occur. The suitability for this has to be assured from the plant manufacturer which may include making appropriate tests.

This document replaces all earlier versions.

Emerson Electric GmbH & Co OHG ALCO CONTROLS Postfach 1251 Heerstraße 111 D-71332 Waiblingen Germany Phone ...49-7151-509-0 Fax ...49-7151-509-200 www.emersonclimate.eu	Benelux	Phone:	Fax:
	Germany, Austria & Switzerland	+31 (0)77 324 0 234	+31 (0)77 324 0 235
	France, Greece, Maghreb	+49 (0)6109 6059 -0	+49 (0)6109 6059 40
	Italia	+33 (0)4 78 66 85 70	+33 (0)4 78 66 85 71
	Spain & Portugal	+39 02 961 781	+39 02 961 788 888
	UK & Ireland	+34 93 41 23 752	+34 93 41 24 2
	Sweden, Denmark, Norway & Finland	+44 (0) 1635 876 161	+44 (0) 1635 877 111
	Eastern Europe & Turkey	+49 (0)2408 929 0	+49 (0)2408 929 528
	Poland	+49 (0)2408 929 0	+49 (0)2408 929 525
	Russia & Cis	+48 (0)22 458 9205	+48 (0)22 458 9255
	Balkan	+7 495 981 9811	+7 495 981 9816
	Romania	+385 (0) 1560 38 75	+385 (0) 1 560 3879
	Ukraine	+40 364 73 11 72	+40 364 73 12 98
		+38 44 4 92 99 24	+38 44 4 92 99 28